

Self Diagnosis
Supported model

SERVICE MANUAL

FE-2 CHASSIS

MODEL	COMMANDER	DEST	CHASSIS NO.	MODEL	COMMANDER	DEST	CHASSIS NO.
KV-21LT1B	RM-887	French	SCC-Q54C-A	KV-21FT2K	RM-887	OIRT	SCC-Q51E-A
KV-21LT1E	RM-887	Spanish	SCC-Q53C-A				
KV-21LT1K	RM-887	OIRT	SCC-Q51C-A				
KV-21LT1U	RM-887	UK	SCC-Q52C-A				

FD Trinitron



KV-21LT1



RM-887



KV-21FT2

TRINITRON® COLOR TV
SONY®

TABLE OF CONTENTS

<i>Section</i>	<i>Title</i>	<i>Page</i>	<i>Section</i>	<i>Title</i>	<i>Page</i>
	Specifications	3	3. SET-UP ADJUSTMENTS		
	Connectors	5	3-1. Beam Landing		16
	Self Diagnostic Software	6	3-2. Convergence		17
1. GENERAL			3-3. Focus Adjustment		19
	Switching On the TV and Automatically Tuning	7	3-4. Screen (G2), White Balance		19
	Introducing the Menu System	8	4. CIRCUIT ADJUSTMENTS		
	Teletext	10	4-1. Electrical Adjustments		20
	Connecting Optional Equipment.....	10	4-2. Test Mode 2		22
	Using Optional Equipment	10	5. DIAGRAMS		
	Troubleshooting	11	5-1. Circuit Board Location		24
2. DISASSEMBLY			5-2. Block Diagrams		25
	KV-21LT1		5-3. Schematic Diagrams and Printed Wiring Boards		24
	2-1. Rear Cover Removal	12	* C Board		29
	2-2. A Board PWB Removal 1	12	* A Board		31
	2-3. A Board PWB Removal 2	12	5-4. Semiconductors		39
	2-4. Service Position	12	5-5. IC Blocks		41
	2-5. Wire Dressing	12	6. EXPLODED VIEWS		
	2-6. Picture Tube Removal	13	6-1. Chassis (KV-21LT1)		42
			Chassis (KV-21FT2)		44
			6-2. Picture Tube(KV-21LT1)		43
			Picture Tube(KV-21FT2)		45
	KV-21FT2		7. ELECTRICAL PARTS LIST		46
	2-7. Rear Cover Removal	14			
	2-8. Chassis Removal	14			
	2-9. Service Position	14			
	2-10. Wire Dressing	14			
	2-11. Picture Tube Removal	15			

CAUTION

SHORT CIRCUIT THE ANODE OF THE PICTURE TUBE AND THE ANODE CAP TO THE METAL CHASSIS, CRT SHIELD, OR THE CARBON PAINTED ON THE CRT, AFTER REMOVAL OF THE ANODE CAP.

WARNING !!

AN ISOLATION TRANSFORMER SHOULD BE USED DURING ANY SERVICE WORK TO AVOID POSSIBLE SHOCK HAZARD DUE TO LIVE CHASSIS, THE CHASSIS OF THIS RECEIVER IS DIRECTLY CONNECTED TO THE POWER LINE.

SAFETY-RELATED COMPONENT WARNING !!

COMPONENTS IDENTIFIED BY SHADING AND MARKED Δ ON THE SCHEMATIC DIAGRAMS, EXPLODED VIEWS AND IN THE PARTS LIST ARE CRITICAL FOR SAFE OPERATION. REPLACE THESE COMPONENTS WITH SONY PARTS WHOSE PART NUMBERS APPEAR AS SHOWN IN THIS MANUAL OR IN SUPPLEMENTS PUBLISHED BY SONY.

ATTENTION

APRES AVOIR DECONNECTE LE CAP DE'LANODE, COURT-CIRCUITER L'ANODE DU TUBE CATHODIQUE ET CELUI DE L'ANODE DU CAP AU CHASSIS METALLIQUE DE L'APPAREIL, OU AU COUCHE DE CARBONE PEINTE SUR LE TUBE CATHODIQUE OU AU BLINDAGE DU TUBE CATHODIQUE.

ATTENTION !!

AFIN D'EVITER TOUT RISQUE D'ELECTROCUTION PROVENANT D'UN CHÂSSIS SOUS TENTION, UN TRANSFORMATEUR D'ISOLEMENT DOIT ETRE UTILISÉ LORS DE TOUT DÉPANNAGE LE CHÂSSIS DE CE RÉCEPTEUR EST DIRECTMENT RACCORDÉ À L'ALIMENTATION SECTEUR.

ATTENTION AUX COMPOSANTS RELATIFS Á LA SECURITÉ!!

LES COMPOSANTS IDENTIFIÉS PAR UNE TRAME ET PAR UNE MARQUE Δ SUR LES SCHÉMAS DE PRINCIPE, LES VUES EXPLOSÉES ET LES LISTES DE PIÉCES SONT D'UNE IMPORTANCE CRITIQUE POUR LA SÉCURITÉ DU FONCTIONNEMENT, NE LES REMPLACER QUE PAR DES COMPSANTS SONY DONT LE NUMÉRO DE PIÉCE EST INDIQUÉ DANS LE PRÉSENT MANUEL OU DANS DES SUPPLÉMENTS PUBLIÉS PAR SONY.

ITEM MODEL	Television System	Channel Coverage	Color System
French	B/G/H, L,I	VHF : E2-E12, F2-F10 UHF : E21-E69 CABLE TV : S01-S03, S1-S20, B-Q HYPER : S21-S41 L F02-F10, F21-F69 I UHF : B21-B69	PAL, SECAM NTSC4.43, NTSC3.58 (VIDEO IN)
Spanish	B/G/H	VHF : E2-E12 UHF : E21-E69 CABLE TV : S01-S03, S1-S20 HYPER : S21-S41	PAL, SECAM NTSC4.43, NTSC3.58 (VIDEO IN)
OIRT	B/G/H, D/K	VHF : E2-E12, R01-R12 UHF : E21-E69, R21-R69 CABLE TV : S01-S03, S1-S20 HYPER : S21-S41	PAL, SECAM NTSC4.43, NTSC3.58 (VIDEO IN)
UK	I	I : UHF B21-B69	PAL, SECAM NTSC4.43, NTSC3.58 (VIDEO IN)

Model	KV-21FT2K	KV-21LT1B	KV-21LT1E	KV-21LT1K	KV-21LT1U
Power Consumption	55W	55W	55W	55W	76W

Picture Tube	Flat Display FD Trinitron Approx. 55cm (21 inches) (Approx. 51 cm picture measured diagonally) 110 degree deflection	Sound output	21LT1B/21LT1E/21LT1K/21LT1U: 1x8W (Music Power) 1x4W (RMS Mono) 21FT2K: 2x6W (Music Power) 2x3W (RMS Mono)
Input/Output Terminals [REAR]		Power Requirements	220 - 240V
1: 21-pin Euro connector (CENELEC standard)	Inputs for Audio and Video signals. Inputs for RGB. Outputs of TV Video and Audio signals.	Dimensions	21LT1B/21LT1E/21LT1K/21LT1U: Approx 514x478x487mm 21FT2K: Approx 488x480x477mm
Input/Output Terminals [FRONT]		Weight	21LT1B/21LT1E/21LT1K/21LT1U: Approx 24kg 21FT2K: Approx 26.1kg
Video input	phono jack	Supplied Accessories	RM-887 Remote Commander (1) IEC designated R6 battery (2)
Audio input	phono jack	Other Features	Teletext, Sleep Timer, Smartlink, TV system Autodetection
Headphone jack	stereo mini jack	Remote control system	Infrared control
		Power requirements	3V dc 2 batteries IEC designation R6 (size AA)
Design and specifications are subject to change without notice.			

Model Name Item	KV-21FT2K	KV-21LT1B	KV-21LT1E	KV-21LT1K	KV-21LT1U
Pal Comb	OFF	OFF	OFF	OFF	OFF
PIP	OFF	OFF	OFF	OFF	OFF
RGB Priority	OFF	ON	ON	OFF	ON
Woofers Box	OFF	OFF	OFF	OFF	OFF
Scart 1	ON	ON	ON	ON	ON
Scart 2	OFF	OFF	OFF	OFF	OFF
Front in (3)	OFF	OFF	OFF	OFF	OFF
Scart 4	OFF	OFF	OFF	OFF	OFF
Projector	OFF	OFF	OFF	OFF	OFF
AKB in 16:9 mode	OFF	OFF	OFF	OFF	OFF
Norm B/G	ON	ON	ON	ON	OFF
Norm I	OFF	ON	OFF	OFF	ON
Norm D/K	ON	OFF	ON	OFF	OFF
Norm AUS	OFF	OFF	OFF	OFF	OFF
Norm L	OFF	ON	OFF	OFF	OFF
Norm SAT	OFF	OFF	OFF	OFF	OFF
Norm M	OFF	OFF	OFF	OFF	OFF
Teletext	ON	ON	ON	ON	ON
Nicam Stereo	OFF	OFF	OFF	OFF	OFF

WARNING (UK Models only)

The flexible mains lead is supplied connected to a **B.S. 1363** fused plug having a fuse of **5 AMP** rating. Should the fuse need to be replaced, use a **5 AMP FUSE** approved by ASTA to **BS 1362**, ie one that carries the  mark.

IF THE PLUG SUPPLIED WITH THIS APPLIANCE IS NOT SUITABLE FOR THE OUTLET SOCKETS IN YOUR HOME, IT SHOULD BE CUT OFF AND AN APPROPRIATE PLUG FITTED. THE PLUG SEVERED FROM THE MAINS LEAD MUST BE DESTROYED AS A PLUG WITH BARED WIRES IS DANGEROUS IF ENGAGED IN A LIVE SOCKET.

When an alternative type of plug is used, it should be fitted with a **5 AMP FUSE**, otherwise the circuit should be protected by a **5 AMP FUSE** at the distribution board.

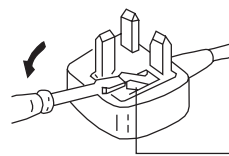

How to replace the fuse.
Open the fuse compartment with a screwdriver blade and replace the fuse.

FUSE

21 pin connector

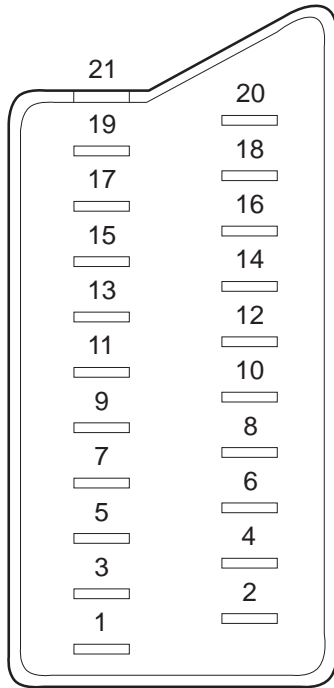

Pin No	1	2	4	Signal	Signal level
1	○	○	○	Audio output B (right)	Standard level : 0.5V rms Output impedance : Less than 1kohm*
2	○	○	○	Audio output B (right)	Standard level : 0.5V rms Output impedance : More than 10kohm*
3	○	○	○	Audio output A (left)	Standard level : 0.5V rms Output impedance : Less than 1kohm*
4	○	○	○	Ground (audio)	
5	○	○	○	Ground (blue)	
6	○	○	○	Audio input A (left)	Standard level : 0.5V rms Output impedance : More than 10kohm*
7	○	●	●	Blue input	0.7 +/- 3dB, 75 ohms positive
8	○	○	○	Function select (AV control)	High state (9.5-12V) : Part mode Low state (0-2V) : TV mode Input impedance : More than 10K ohms Input capacitance : Less than 2nF
9	○	○	○	Ground (green)	
10	○	○	○	Open	
11	○	●	●	Green	Green signal : 0.7 +/- 3dB, 75 ohms, positive
12	○	○	○	Open	
13	○	○	○	Ground (red)	
14	○	○	○	Ground (blanking)	
15	○	-	-	Red input	0.7 +/- 3dB, 75 ohms, positive
	-	○	○	(S signal Chroma input)	0.3 +/- 3dB, 75 ohms, positive
16	○	●	●	Blanking input (Y's signal)	High state (1-3V) Low state (0-0.4V) Input impedance : 75 ohms
17	○	○	○	Ground (video output)	
18	○	○	○	Ground (video input)	
19	○	○	○	Video output	1V +/- 3dB, 75ohms, positive sync 0.3V (-3+10dB)
20	○	-	-	Video input	1V +/- 3dB, 75ohms, positive sync 0.3V (-3+10dB)
	-	○	○	Video input Y (S signal)	1V +/- 3dB, 75ohms, positive sync 0.3V (-3+10dB)
21	○	○	○	Common ground (plug, shield)	

○ Connected ● Not Connected (open) * at 20Hz - 20kHz

Rear Connection Panel

KV-21LT1

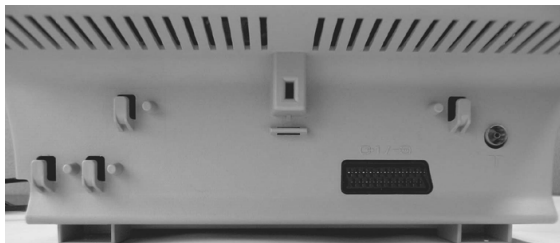

KV-21FT2

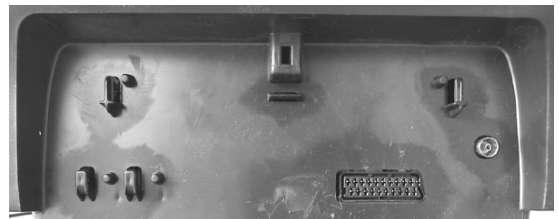

Front Connection Panel

KV-21LT1



KV-21FT2



FE-2 SELF DIAGNOSTIC SOFTWARE

The identification of errors within the FE-2 chassis is triggered in one of two ways :- 1: Busy or 2: Device failure to respond to IIC. In the event of one of these situations arising the software will first try to release the bus if busy (Failure to do so will report with a continuous flashing LED) and then communicate with each device in turn to establish if a device is faulty. If a device is found to be faulty the relevant device number will be displayed through the LED (Series of flashes which must be counted) See table 1., non fatal errors are reported using this method. Each time the software detects an error it is stored within the NVM. See Table 2.

Table 1

Error Message	LED Code
No error	00
Reserved	01
OCP (Over Current Protection)	02
Reserved	03
No Vertical Sync	04
Unstable AKB	05
IIC bus clock and/or data lines low at power on	06
NVM no IIC bus acknowledge at power on	07
Not Used	08
Tuner no acknowledge at power on	09
Not used	10
Jungle controller no acknowledge at Power ON	11

How to enter into Table 2

1. Turn on the main power switch of the TV set and enter into the 'Standby Mode'.
2. Press the following sequence of buttons on the Remote Commander.

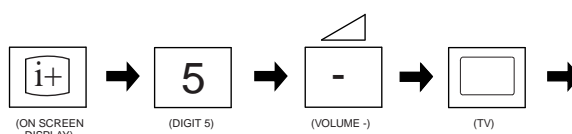

3. The following table will be displayed indicating the error count.

Flash Timing Example : e.g. error number 3

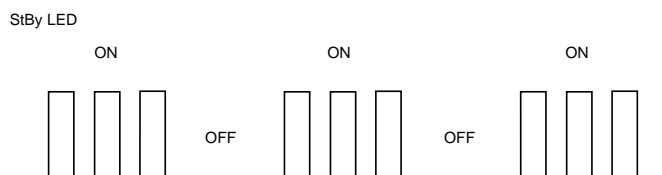

Table 2

ERROR MENU			
E02	OCP	(0, 255)	0
E03	OVP N/A	(0, 255)	0
E04	VSYNC	(0, 255)	0
E05	IKR	(0, 255)	0
E06	IIC	(0, 255)	0
E07	NVM	(0, 255)	0
E08	JUNGLE	(0, 255)	0
E09	TUNER	(0, 255)	0
E10	SOUNDP	(0, 255)	0
E11	8V	(0, 255)	0
WORKING TIME			
HOURS			0
MINUTES			0

Note: To clear the error count data press '80' on the Remote commander.

The operating instructions mentioned here are partial abstracts from the 'Operating Instruction Manual'. The page numbers of the 'Operating Instruction Manual' remain as in the manual.

Switching On the TV and Automatically Tuning

i The first time you switch on your TV, a sequence of menu screens appear on the TV enabling you to: 1) choose the language of the menu screen, 2) choose the country in which you wish to operate the TV, 3) search and store all available channels (TV Broadcast) and 4) change the order in which the channels (TV Broadcast) appear on the screen. However, if you need to change the language menu, change or repeat the tuning (e.g. when you move house) or rearrange again the order of the channels afterwards, you can do that by selecting the appropriate menu in the **Menu** (Set Up). For more information, refer to the 'Menu Guide' section of this instruction manual. You can also do that by pressing the Auto Start Up Button **▶▶** on the TV set.

1 Connect the TV plug to the mains socket (220-240V AC, 50Hz).

Press the **On/Off** button on the TV set to turn on the TV. The first time you press this button, a **Language** menu displays automatically on the TV screen.

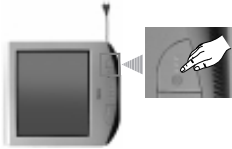

2 Press the **Up** or **Down** button on the remote control to select the language, then press the **OK** button to confirm your selection. From now on all the menus will appear in the selected language.

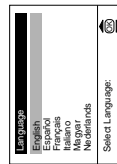

3 The **Country** menu appears automatically on the TV screen. Press the **Up** or **Down** button to select the country in which you will operate the TV set, then press the **OK** button to confirm your selection.

- i** Select " " instead of a country
- If the country in which you want to use the TV set does not appear in the list.
 - If you do not want your channels (TV Broadcast) stored in a given channel sequence starting from programme position 1.

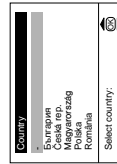

4 The **Auto Tuning** menu appears on the screen. Press the **OK** button to select **Yes**.



continued...

First Time Operation

SECTION 1 GENERAL

5 A new menu appears on the screen asking you to check that the aerial is connected. Ensure the aerial is connected and then press the **OK** button to start the automatic tuning.

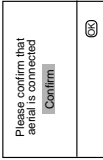

i The TV starts to automatically search and store all available channels (TV Broadcast) for you.

⚠ This procedure could take some minutes. Please be patient and do not press any button. Otherwise the automatic tuning will not be completed.

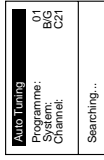

6 After all available channels are captioned and stored, the **Programme Sorting** menu appears automatically on the screen enabling you to change the order in which the channels appear on the screen.

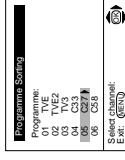

a) If you do not wish to change the channel order, go to step 7.

b) If you wish to change the channel order:

- 1 Press the **Up** or **Down** button to select the programme number with the channel (TV Broadcast) you wish to rearrange, then press the **Right** button.
- 2 Press the **Up** or **Down** button to select the new programme number position for your selected channel (TV Broadcast), then press **Left**.
- 3 Repeat steps b)1 and b)2 if you wish to change the order of the other channels.

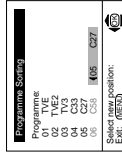

7 Press the **MENU** button to remove the menu from the screen.



👉 Your TV is now ready for use

First Time Operation

Introducing and Using the Menu System

1 Your TV uses an on-screen menu system to guide you through the operations. Use the following buttons on the Remote Control to operate the menu system:



1 Press the **MENU** button to switch the first level menu on.



2 To highlight the desired menu or option, press **↔** or **↕**.

- To enter to the selected menu or option, press **↵**.

- To return to the last menu or option, press **↶**.

- To alter settings of your selected option, press **↔** / **↕** / **↶** or **↷**.

- To confirm and store your selection, press **OK**.



3 Press the **MENU** button to remove the menu from the screen.

Menu Guide

Level 1

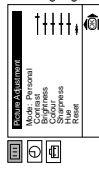

Level 2

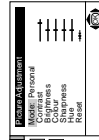

Level 3 / Function

PICTURE ADJUSTMENT
The "Picture Adjustment" menu allows you to alter the picture adjustments.

To do that: after selecting the item you want to alter press **↔**, then press repeatedly **↔** / **↕** / **↶** or **↷** to adjust it and finally press **OK** to store the new adjustment.

This menu also allows you to customise the picture mode based on the programme you are watching:

- **Personal** (for individual settings).
- **Live** (for live broadcast programmes).
- **Movie** (for films).

- **Brightness, Colour and Sharpness** can only be altered if "Personal" mode is selected.

- **Hue** is only available for NTSC colour signal (e.g. USA video tapes).

- Select **Reset** and press **OK** to reset the picture to the factory preset levels.

continued...

Level 1 Level 2 Level 3 / Function

SLEEP TIMER

The "Sleep Timer" option in the "Timer" menu allows you to select a time period for the TV to switch itself automatically into the standby mode.

To do that: after selecting the option press **↵**, then press **↔** or **↕** to set the time period delay (max. of 4 hours) and finally press **OK** to store.

- While watching the TV, you can press the **(E)** button on the remote control to display the time remaining.
- One minute before the TV switches itself into standby mode, the time remaining is displayed on the TV screen automatically.

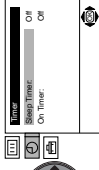

ON TIMER

The "On Timer" option in the "Timer" menu allows you to select a time period for the TV to switch itself automatically on from standby mode.

To do that: after selecting the option press **↵**, then press **↔** or **↕** to set the time period delay (max. 12 hours) and press **OK** to store. Finally press the standby button **|/|** on the remote control. After the selected length of time the TV switches on automatically.

- The standby indicator **⏻** on the TV set flashes regularly to indicate that "On Timer" is active.
- Any loss of power will cause these settings to be cleared.

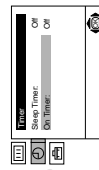
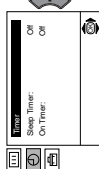
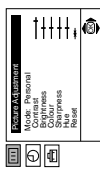

LANGUAGE / COUNTRY

The "Language/Country" option in the "Set Up" menu allows you to select the language that the menus are displayed in. It also allows you to select the country in which you wish to operate the TV set.

To do that: after selecting the option, press **↵** and then proceed in the same way as in the steps 2 and 3 of the section "Switching On the TV and Automatically Tuning".

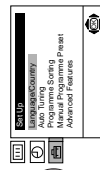
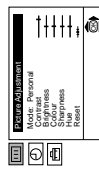

continued...

Level 1 | **Level 2** | **Level 3 / Function**

3 After selecting the **Channel** option, press **↵**. Then press **↵** or **↵** to select the channel tuning ("C" for terrestrial channels or "S" for cable channels). Next press **↵**. After that, press the number buttons to enter directly the channel number of the TV Broadcast or the channel of the VCR signal. If you do not know the channel number, press **↵** or **↵** to search for it. When you tune the desired channel, press **OK** twice to store.

Repeat all the above steps to tune and store more channels.

b) Normally the automatic fine tuning (AFT) is operating, however you can manually fine tune the TV to obtain a better picture reception in the case that the picture is distorted.

To do that: while watching the channel (TV Broadcast) you wish to fine tune, select the **AFT** option and press **↵**. Next press **↵** or **↵** to adjust the fine tuning between -15 and +15. Finally press **OK** twice to store.

c) Skip any unwanted programme numbers when they are selected with the **PROGR** +/- buttons.

To do that: Highlighting the **Programme** option, press the **PROGR** +/- button to select the programme number you want to skip. When the programme you want to skip appears on the screen, select the **Skip** option and press **↵**. Next press **↵** or **↵** to select **Yes**. Finally press **OK** twice to confirm and store.

To cancel this function afterwards, select "No" instead of "Yes" in the step above.

d) Label a channel using up to five characters.

To do that: Highlighting the **Programme** option, press the **PROGR** +/- button to select the programme number with the channel you wish to name. When the programme you want to name appears on the screen, select the **Label** option and press **↵**. Next press **↵** or **↵** to select a letter, number or "-" for a blank. Press **↵** to confirm this character. Select the other four characters in the same way. After selecting all the characters, press **OK** twice to store.

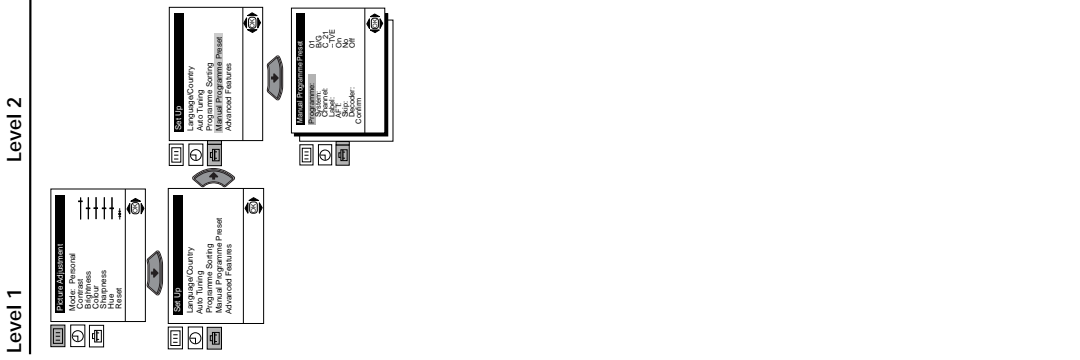

Level 1 | **Level 2** | **Level 3 / Function**

AUTO TUNING

The "Auto Tuning" option in the "Set Up" menu allows you to automatically search for and store all available TV channels.

To do that: after selecting the option, press **↵** and then proceed in the same way as in TV steps 4 and 5 of the section "Switching On the TV and Automatically Tuning".

PROGRAMME SORTING

The "Programme Sorting" option in the "Set Up" menu allows you to change the order in which the channels (TV Broadcast) appear on the screen.

To do that: after selecting the option, press **↵** and then proceed in the same way as in step 6 b) of the section "Switching On the TV and Automatically Tuning".

MANUAL PROGRAMME PRESET

The "Manual Programme Preset" option in the "Set Up" menu allows you to:

a) Preset channels or a video input source one by one to the programme order of your choice. To do that:

- 1 After selecting the "Manual Programme Preset" option, press **↵** then with **Programme** option highlighted press **↵**. Press **↵** or **↵** to select on which programme number you want to preset the channel (for VCR, select programme number "0"). Then press **↵**.
- 2 After selecting the **System** option, press **↵**. Then press **↵** or **↵** to select the TV Broadcast system (B/G for western European countries or D/K for eastern European countries). Then press **↵**.

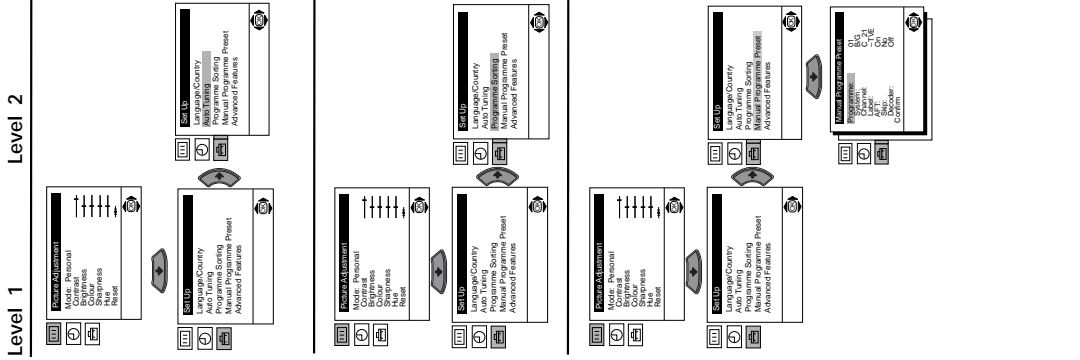

GB

continued...

continued...

Teletext

i Teletext is an information service transmitted by most TV stations. The index page of the teletext service (usually page 100) gives you information on how to use the service. To operate teletext, use the remote control buttons as indicated below.

A Make sure to use a channel (TV Broadcast) with a strong signal, otherwise teletext errors may occur.

To Switch On Teletext :

After select the channel (TV Broadcast) which carries the teletext you wish to view, press **⏏**.

To Select a Teletext page:

Input 3 digits for the page number, using the numbered buttons.

- If you have made a mistake, retype the correct page number.
- If the counter on the screen continues searching, it is because this page is not available. In that case, input another page number

To access the next or preceding page:

Press **PROGR** + **⏏** or **PROGR** - **⏏**.

To superimpose teletext on to the TV:

Whilst you are viewing teletext, press **⏏**. Press it again to cancel teletext mode.

To freeze a teletext page:

Some teletext pages have sub-pages which follow on automatically. To stop them, press **⏏** / **⏏**. Press it again to cancel the freeze.

To reveal concealed information (e.g. answer to a quiz):

Press **⏏** / **⏏**. Press it again to conceal the information.

To Switch Off Teletext:

Press **⏏**.

Fastext

i Fastext service lets you access pages with one button push.

While you are in Teletext mode and Fastext is broadcast, a colour coded menu appears at the bottom of the teletext page. Press the colour button (red, green, yellow or blue) to access the corresponding page.

Connecting Optional Equipment

i Using the following instructions, you can connect a wide range of optional equipment to your TV set. (Connecting cables are not supplied).

Connecting a VCR:

To connect a VCR, please refer to the section "Connecting the aerial and VCR" of this instruction manual. We recommend you connect your VCR using a scart lead. If you do not have a scart lead, tune in the VCR test signal to TV programme number "0".

by using "Manual Programme Preset" option. (for details how to manual programme, see page 11, step a).

Also refer to your VCR instruction manual to find out how to find the output channel of your VCR.

If you have connected a decoder to a VCR which supports Smartlink feature:

Select the "Manual Programme Preset" option in the "Set Up" menu and after entering in the "Decoder" option, select "On" (by using **⏏** or **⏏**) to each scrambled channel.

*This option is only available depending the country you have selected in the "Country" menu.

** "PlayStation" is a product of Sony Computer Entertainment, Inc.

** "PlayStation" is a trademark of Sony Computer Entertainment, Inc.

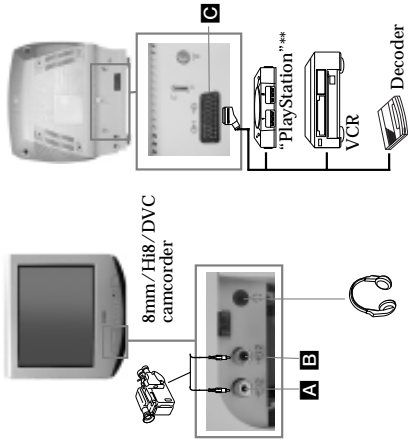

Using Optional Equipment

- 1 Connect your equipment to the designated TV socket, as indicated above.
- 2 To watch the picture of the connected equipment, press the **⏏** button repeatedly until the correct input symbol appears on the screen.

Symbol	Input Signals
⏏ 1	• Audio / video input signal through the Scart connector C
⏏ 2	• RGB input signal through the Scart connector C . This symbol appears only if a RGB source has been connected.
⏏ 3	• Video input signal through the phono socket A and Audio input signal through B .
- 3 Switch on the connected equipment.
- 4 Press **⏏** button on the remote control to return to the normal TV picture.

Troubleshooting

 Here are some simple solutions to the problems which may affect the picture and sound.

Problem	Solution
No picture (screen is dark) and no sound.	<ul style="list-style-type: none"> • Check the aerial connection. • Plug the TV in and press the ⏻ button on the front of TV. • If the standby indicator ⏻ is on, press I/⏻ button on the remote control.
Poor or no picture (screen is dark), but good sound.	<ul style="list-style-type: none"> • Using the menu system, select the "Picture Adjustment" menu and select "Reset" to return to the factory settings.
No picture or no menu information from the equipment connected to the Scart connector.	<ul style="list-style-type: none"> • Check that the optional equipment is on and press the ⏻ button repeatedly on the remote control until the correct input symbol is displayed on the screen.
Good picture, no sound.	<ul style="list-style-type: none"> • Press the ⏻ +/- button on the remote control.
No colour on colour programmes.	<ul style="list-style-type: none"> • Using the menu system, select the "Picture Adjustment" menu and select "Reset" to return to factory settings.
Distorted picture when changing programmes or selecting teletext.	<ul style="list-style-type: none"> • Turn off any equipment connected to the Scart connector on the rear of the TV.
Picture slanted (only for KV-Z1LTHK)	<ul style="list-style-type: none"> • Using the menu system, select the "Picture Rotation" option in the "Advanced Features" menu to correct the picture slant.
Noisy picture when viewing a TV channel.	<ul style="list-style-type: none"> • Using the menu system, select the "Manual Programme Preset" menu and adjust Fine Tuning (AFT) to obtain better picture reception. • Using the menu system, select the "Noise Reduction" option in the "Advanced Features" menu and select "On" to reduce the noise in the picture.
Remote control does not function.	<ul style="list-style-type: none"> • Replace the batteries.
The standby indicator ⏻ on the TV flashes even though the "On Timer"	<ul style="list-style-type: none"> • Contact to your nearest Sony service centre.

 In case of problems, have your TV serviced by qualified personnel. Never open the casing yourself.

SECTION 2 DISASSEMBLY

KV-21LT1

2-1. Rear Cover Removal



Release the mains power cable from its securing posts. Remove the rear cover fixing screws indicated. Pull the rear cover away from the front beznet until clear of chassis.

Note : Use a cross-head screwdriver with a blade length of at least 200mm.

2-2. A Board PWB Removal [Step 1]



Remove screw.

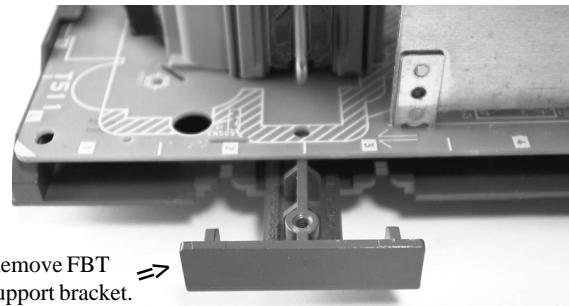

Remove FBT support bracket.

2-3. A Board PWB Removal [Step 2]

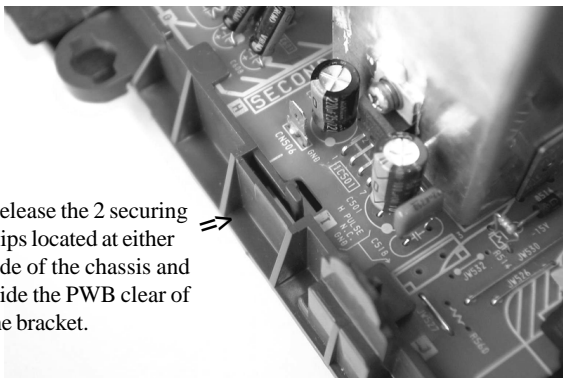

Release the 2 securing clips located at either side of the chassis and slide the PWB clear of the bracket.

2-5. Wire Dressing

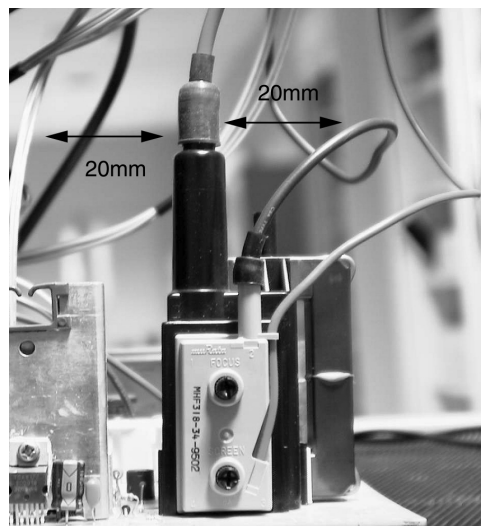

Ensure that all wires do not touch heat-sinks and high temperature hot spots. All wires must be kept at a minimum distance of 20mm away from the EHT lead.

2-4. Service Position

Place the A Board PWB in the position indicated to carry out servicing.

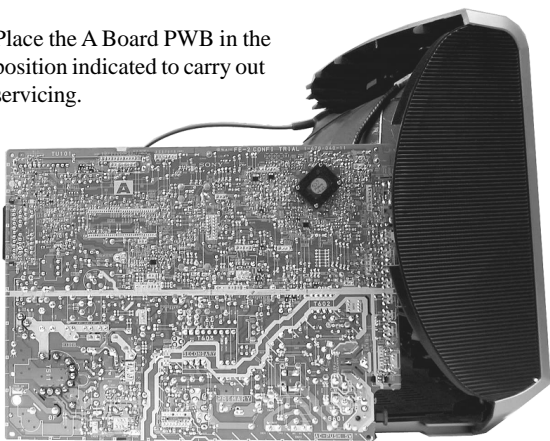

2-6. Picture Tube Removal

WARNING: BEFORE REMOVING THE ANODE CAP

High voltage remains in the CRT even after the power is disconnected. To avoid electric shock, discharge CRT *before* attempting to remove the anode cap. Short between anode and CRT coated earth ground strap.

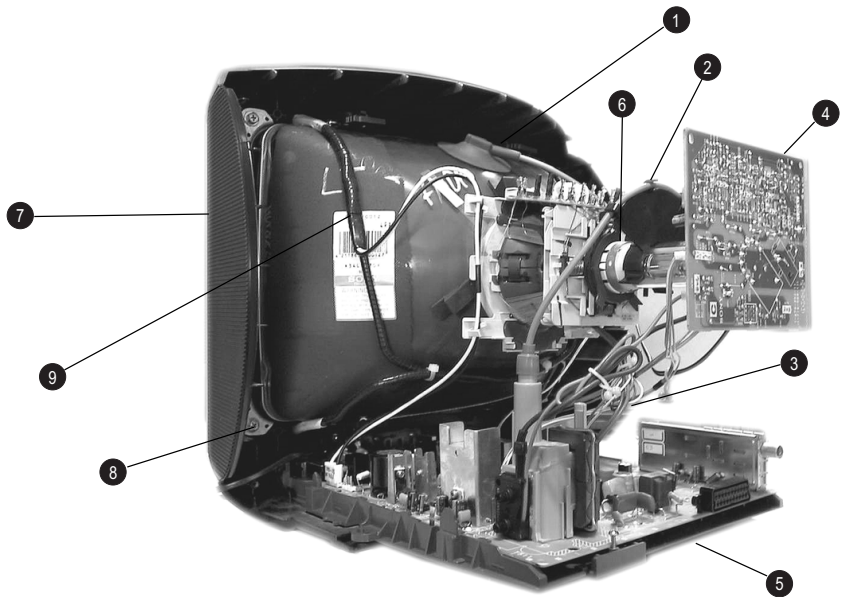
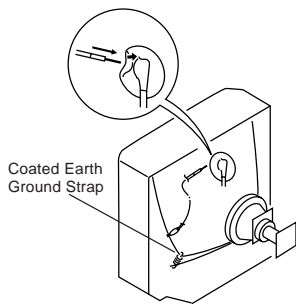

1. Discharge the anode of the CRT and remove the anode cap.
2. Release the EHT lead from its CRT support bracket.
3. Unplug all interconnecting leads from the Deflection yoke, degaussing coils and CRT grounding strap.
4. Remove the C Board from the CRT.
5. Remove the chassis assembly.
6. Loosen the Deflection yoke fixing screw and remove.
7. Place the set with the CRT face down on a cushion.
8. Unscrew the four CRT fixing screws [located on each CRT corner] and remove the CRT.
9. Remove the Degaussing Coils.
Remove the CRT grounding strap and spring tentioners.
[Take care not to handle the CRT by the neck.]

Removal of the Anode-Cap

* REMOVING PROCEDURES.

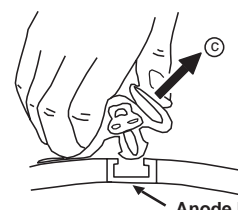
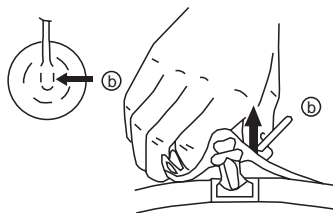
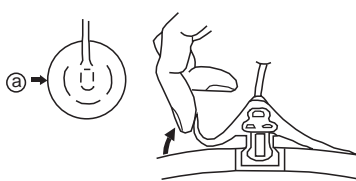

- ① Turn up one side of the rubber cap in the direction indicated by the arrow (a)
- ② Using a thumb pull up the rubber cap firmly in the direction indicated by the arrow (b)
- ③ When one side of the rubber cap is separated from the anode button, the anode-cap can be removed by turning up the rubber cap and pulling it up in the direction of the arrow (c)

How to handle the Anode-Cap

1. To prevent damaging the surface of the anode-cap do not use sharp materials.
2. Do not apply too great a pressure on the rubber, as this may cause damage to the anode connector.
3. A metal fitting called a shatter hook terminal is fitted inside the rubber cap.
4. Do not turn the rubber foot over excessively, this may cause damage if the shatter hook sticks out.

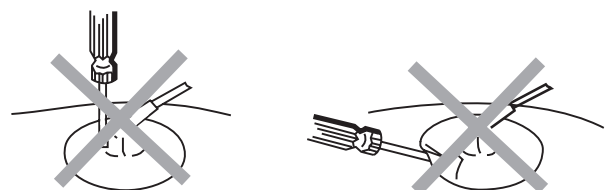

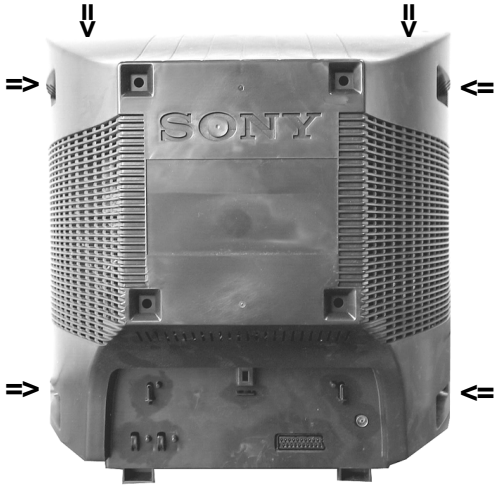
2-7. Rear Cover Removal

Remove the rear cover fixing screws indicated. Pull the rear cover straight back until clear of chassis.

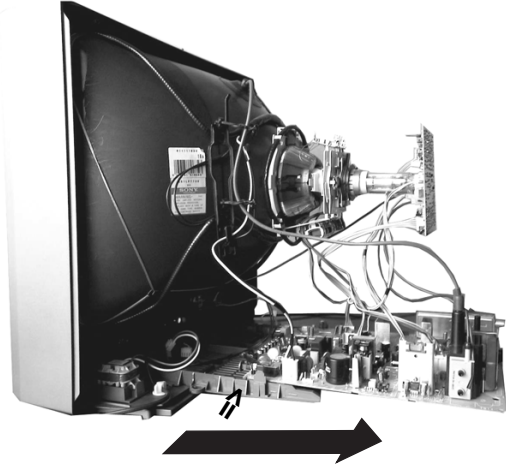
2-8. Chassis Removal and Refitting

To remove the chassis release the clips indicated at opposite sides of the main bracket and slide the chassis away from the beznet. Ensure that the interconnecting leads are released from their purse locks to prevent damage being caused.

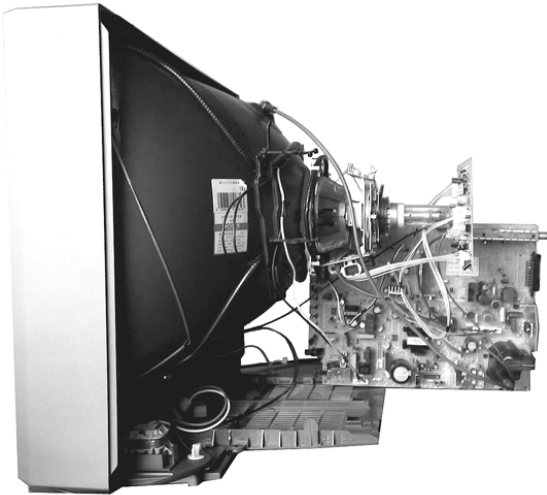
2-9. Service Position

Position the A board as shown to gain access to its solder side. Take care not to trap the interconnecting leads in the process.

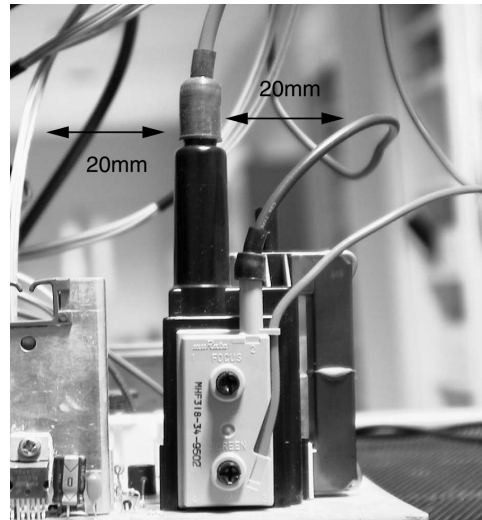
2-10. Wire Dressing

Ensure that all wires do not touch heat-sinks and high temperature hot spots. All wires must be kept at a minimum distance of 20mm away from the EHT lead.

2-11. Picture Tube Removal

WARNING: BEFORE REMOVING THE ANODE CAP

High voltage remains in the CRT even after the power is disconnected. To avoid electric shock, discharge CRT *before* attempting to remove the anode cap. Short between anode and CRT coated earth ground strap.

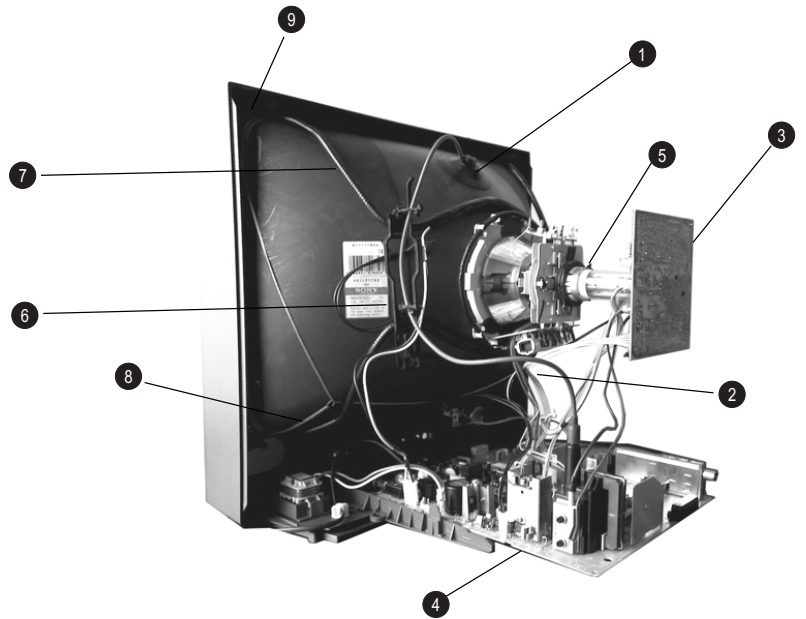
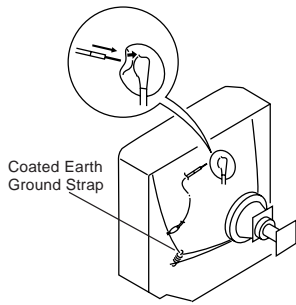

1. Discharge the anode of the CRT and remove the anode cap.
2. Unplug all interconnecting leads from the Deflection yoke, neck assy, degaussing coils and CRT grounding strap.
3. Remove the C Board from the CRT.
4. Remove the chassis assembly.
5. Loosen the Deflection yoke fixing screw and remove.
6. Place the set with the CRT face down on a cushion and remove the Degaussing Coil holders.
7. Remove the Degaussing Coils.
8. Remove the CRT grounding strap and spring tensioners.
9. Unscrew the four CRT fixing screws [located on each CRT corner] and remove the CRT.
[Take care not to handle the CRT by the neck.]

Removal of the Anode-Cap

* REMOVING PROCEDURES.

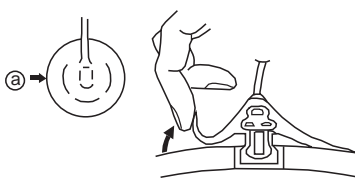

- ① Turn up one side of the rubber cap in the direction indicated by the arrow (a)

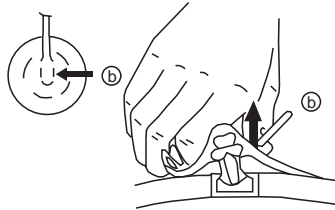

- ② Using a thumb pull up the rubber cap firmly in the direction indicated by the arrow (b)

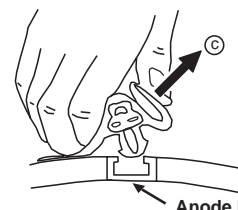

- ③ When one side of the rubber cap is separated from the anode button, the anode-cap can be removed by turning up the rubber cap and pulling it up in the direction of the arrow (c)

How to handle the Anode-Cap

1. To prevent damaging the surface of the anode-cap do not use sharp materials.
2. Do not apply too great a pressure on the rubber, as this may cause damage to the anode connector.
3. A metal fitting called a shatter hook terminal is fitted inside the rubber cap.
4. Do not turn the rubber foot over excessively, this may cause damage if the shatter hook sticks out.

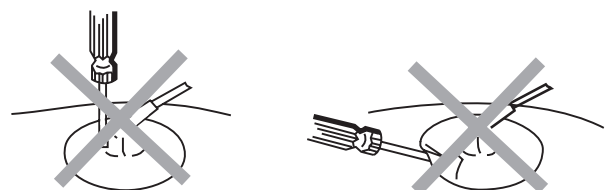

SECTION 3 SET-UP ADJUSTMENTS

- When complete readjustment is necessary or a new picture tube is installed, carry out the following adjustments.
- Unless there are specific instructions to the contrary, carry out these adjustments with the rated power supply.
- Unless there are specific instructions to the contrary, set the controls and switches to the following settings :

Contrast 80% [or remote control normal]
 Brightness 50%

Carry out the adjustments in the following order :

- 3-1. Beam Landing.
- 3-2. Convergence.
- 3-3. Focus.
- 3-4. White Balance.

- Note :** Test equipment required.
1. Color bar/pattern generator.
 2. Degausser.
 3. Oscilloscope.
 4. Digital multimeter.

Preparation:

1. In order to reduce the influence of geomagnetism on the set's picture tube, face it in an easterly or westerly direction.
2. Switch on the set's power and degauss with the degausser.

3-1. Beam Landing

1. Input an all white signal from the pattern generator. Set the Contrast and Brightness to normal.
2. Set the pattern generator raster signal to Red.
3. Move the deflection yoke forward and adjust with the purity control so that the Red is at the centre and the Blue and Green take up equally sized areas on each side of the screen. [See Fig.3-1 - 3-3].
4. Move the deflection yoke backwards and adjust so that the entire screen becomes Red. [See Fig.3-1]
5. Switch the raster signal to Blue, then to Green and verify the condition.
6. When the position of the deflection yoke has been determined, fasten the deflection yoke with the screws.
7. If the beam does not land correctly in all the corners, use a magnet to correct it. [See Fig.3-4]

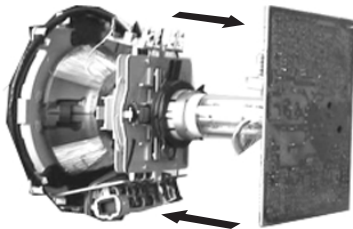

Fig. 3-1.

Caution :

High voltages are present on the Deflection yoke terminals - take care when handling the Deflection yoke whilst carrying out adjustments.

Fig. 3-2.

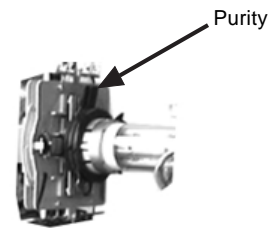

Fig. 3-3.

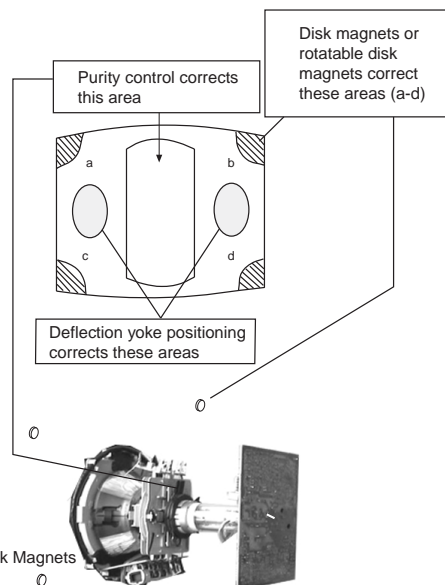
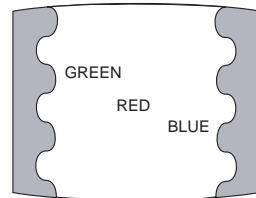

Fig.3-4

3-2. Convergence

Preparation:

- Before starting this adjustment, adjust the focus, horizontal size and vertical size.
- Minimize the Brightness setting.
- Input a dot pattern from the pattern generator.

Horizontal and Vertical Static Convergence

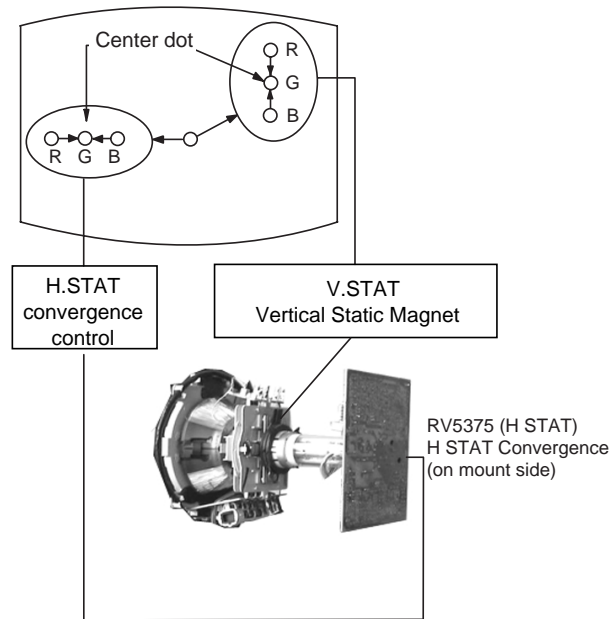
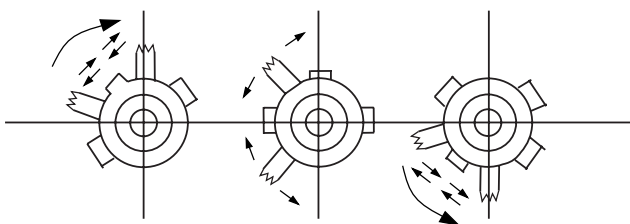

Fig.3-5

1. [Moving horizontally], adjust the H.STAT control so that the Red, Green and Blue points are on top of each other at the centre of the screen.
2. [Moving vertically], adjust the V.STAT magnet so that the Red, Green and Blue points are on top of each other at the centre of the screen.
3. If the H.STAT variable resistor is unable to bring the Red, Green and Blue points together at the centre of the screen, adjust the horizontal convergence with the H.STAT variable resistor and the V.STAT magnet in the manner indicated below.
[In this case, the H.STAT variable resistor and the V.STAT magnet influence each other].

- Tilt the V.STAT magnet and adjust the static convergence by opening or closing the V.STAT magnet.



4. If the V.STAT magnet is moved in the direction of the (a) and (b) arrows, the Red, Green and Blue points move as indicated below.

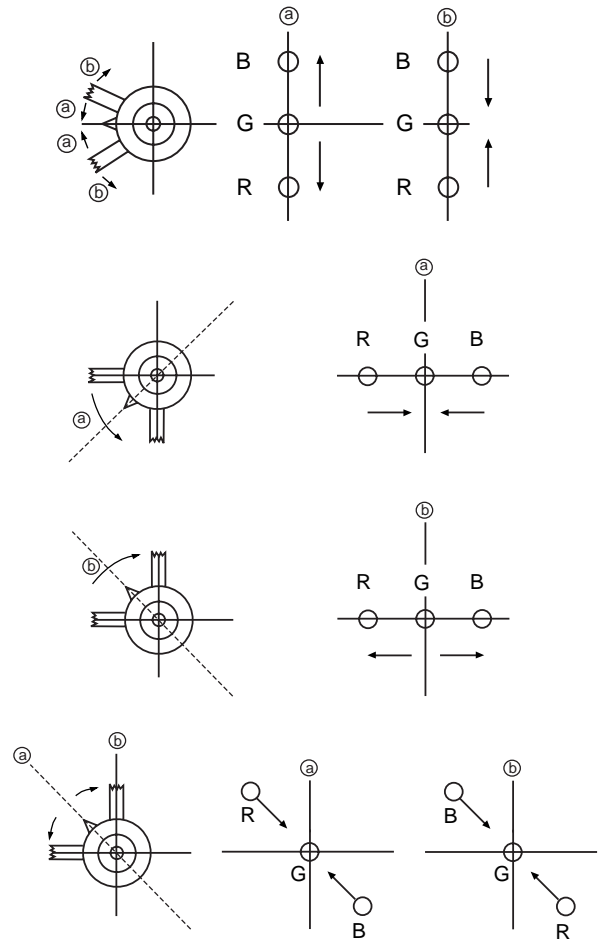

Operation of the BMC (Hexapole) magnet.

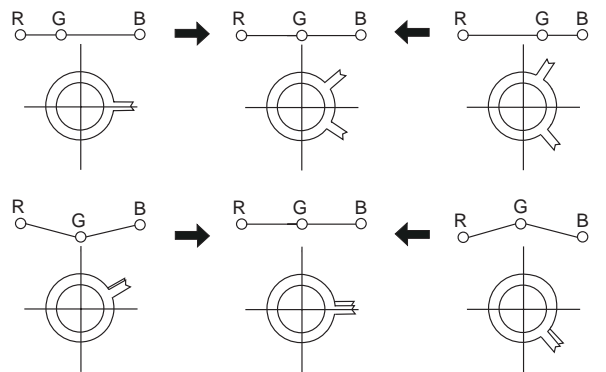

The movement of the magnets interact with each other and so the respective dot position should be monitored while carrying out this adjustment.

Use the H.STAT VR to adjust the Red, Green and Blue dots so that they coincide at the centre of the screen (by moving the dots in the horizontal direction).

Geometry Adjustment.

Preparation:

Before starting this adjustment, adjust the horizontal and vertical static convergence.

1. Remove the deflection yoke spacer.
2. Tilt the deflection yoke as indicated in the figure below and optimise the geometry.
Tilting the DY Up and Down will balance the upper and lower pin adjustment.
Tilting the DY Left and Right will balance the H-Trap adjustment.
3. Re-install the deflection yoke spacer.

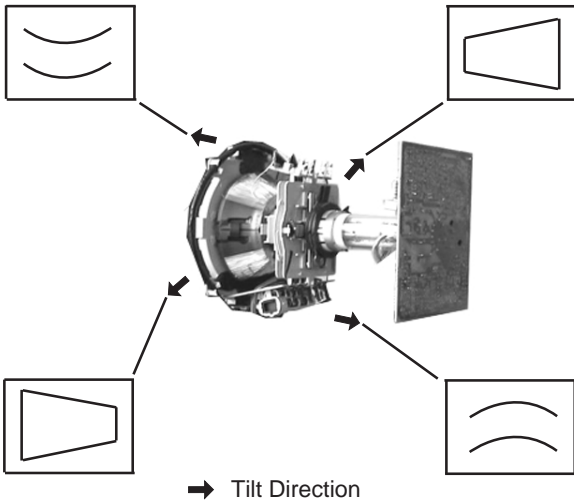

HTIL Adjustment

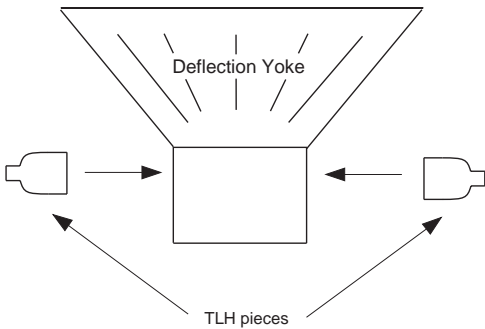

HTIL correction can be performed by adding a TLH correction assembly to the Deflection yoke.

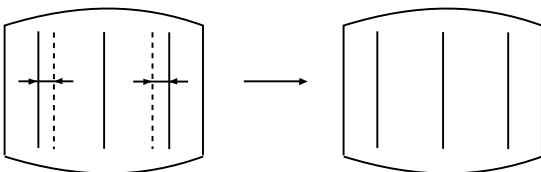

YCH Adjustment

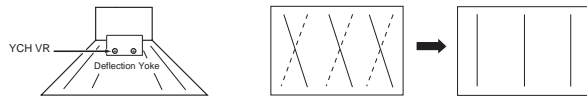

TLV Adjustment

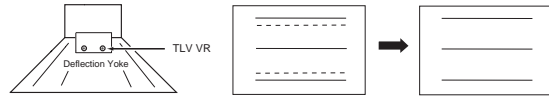

Screen Corner Convergence

If you are unable to adjust the corner convergence properly, this can be corrected with the use of permalloy magnets.

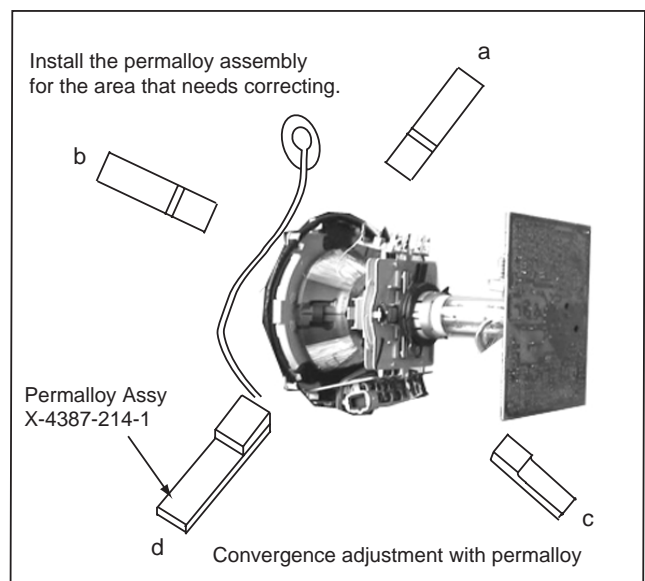
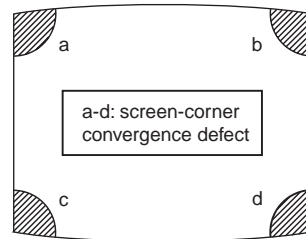

Layout of each control

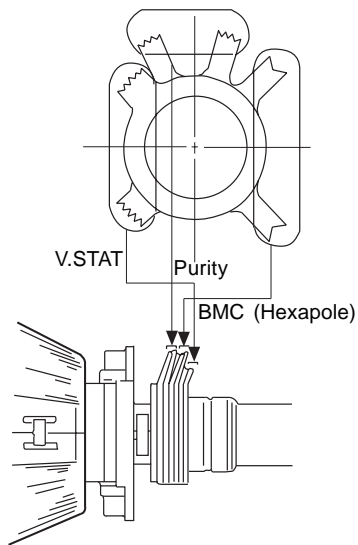

3-3. Focus Adjustment

1. Receive a television broadcast signal.
2. Normalize the picture setting.
3. Adjust the focus control located on the flyback transformer to obtain the best focus at the centre of the screen. Bring only the centre area of the screen into focus, the magenta-ring appears on the screen. In this case, adjust the focus to optimize the screen uniformly.

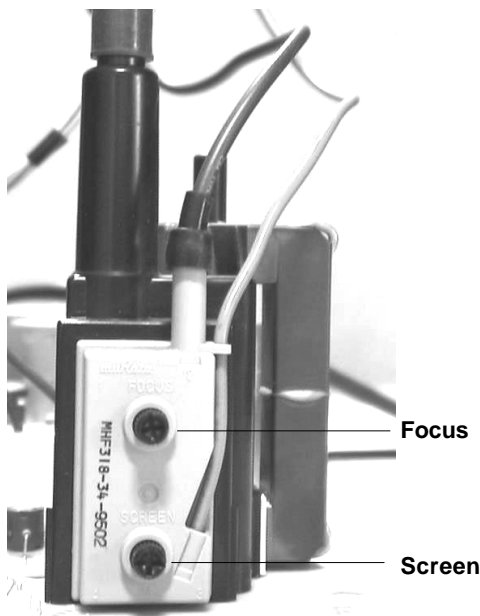

3-4. Screen (G2), White Balance

[Adjustment in the service mode using the remote commander]

G2 adjustment

1. Input a dot signal from the pattern generator.
2. Set the Picture, Brightness and Colour to minimum.
3. Apply 175V DC from an external power supply to the R, G and B cathodes of the CRT.
4. Whilst watching the picture, adjust the G2 control [SCREEN] located on the Flyback Transformer to the point just before the flyback return lines disappear.

White balance adjustment for TV mode

1. Input an all-white signal from the pattern generator.
2. Enter into the 'Service Mode' by pressing 'TEST', 'TEST' and 'MENU' on the Service Commander.
3. Select 'Service' from the on screen menu display and press the right arrow button on the remote commander.
4. The 'Service' menu will appear on the screen. [See Page 18]
5. Set the 'Contrast' to MAX.
6. Set the 'R-Drive' to 25.
7. Adjust the 'G-Drive' and the 'B-Drive' so that the white balance becomes optimum.
8. Press the 'OK' button to write the data for each item.
9. Set the 'Contrast' to MIN.
10. Adjust the 'G-Cutoff', and the 'R-Cutoff' with the left and right buttons on the remote commander so that the white balance becomes optimum.
11. Press the 'OK' button to write the data for each item.

SECTION 4 CIRCUIT ADJUSTMENTS

4-1. Electrical Adjustments

Service adjustments to this model can be performed using the supplied Remote Commander RM-887.

How to enter into the Service Mode

1. Turn on the main power switch and enter into the stand-by mode.
2. Press the following sequence of buttons on the Remote Commander.

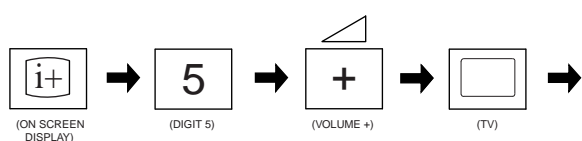

'TT—' will appear in the upper right corner of the screen.
Other status information will also be displayed.

3. Press 'MENU' on the remote commander to obtain the following menu on the screen.

Geometry
Service
Design
Status
IF adjust
Error Menu
FE-2 Mono v1.12
Factory data 00h 00h

4. Move to the corresponding adjustment item using the up or down arrow buttons on the Remote Commander.
5. Press the right arrow button to enter into the required menu item.
6. Press the 'Menu' button on the Remote Commander to quit the Service Mode when all adjustments have been completed.

Note :

- Before performing any adjustments ensure that the correct model has been selected in the 'Model Setting' menu.
- After carrying out the service adjustments, to prevent the customer accessing the 'Service Menu' switch the TV set OFF and then ON.

SERVICE

Offset-R	(0, 15)	Adj
Offset-G	(0, 15)	Adj
R-Drive	(0, 63)	25
G-Drive	(0, 63)	Adj
B-Drive	(0, 63)	Adj
Peak-Freq	(0, 3)	0
Luma-Delay	(0, 15)	8
SC0	(0, 3)	3
White-Peak	(0, 15)	15
Subcont	(0, 15)	Adj
Subright	(0, 63)	Adj
Subcol	(0, 63)	Adj
Subsharp	(0, 63)	31
Br OSD	(0, 15)	11
Br TXT	(0, 15)	8

GEOMETRY

Left-HBlk	(0, 15)	13
Right-HBlk	(0, 15)	9
V-Angle	(0, 63)	Adj
V-Bow	(0, 63)	Adj
H-Centre	(0, 63)	Adj
H-Size	(0, 63)	Adj
Pin-Amp	(0, 63)	Adj
U-Corner-Pin	(0, 63)	Adj
L-Corner-Pin	(0, 63)	Adj
Pin Phase	(0, 63)	Adj
V-Linearity	(0, 63)	Adj
V-Size	(0, 63)	Adj
S-Correction	(0, 63)	Adj
V-Centre	(0, 63)	Adj
V-Zoom	(0, 63)	25

ERROR MENU

E02	OCP	(0, 255)	0
E03	OVP N/A	(0, 255)	0
E04	VSYNC	(0, 255)	0
E05	IKR	(0, 255)	0
E06	IIC	(0, 255)	0
E07	NVM	(0, 255)	0
E08	JUNGLE	(0, 255)	0
E09	TUNER	(0, 255)	0
E10	SOUNDP	(0, 255)	0
E11	8V	(0, 255)	0

WORKING TIME

HOURS	0
MINUTES	0

IF ADJUST

AGC Adjust	(0, 255)	0
Automute	(0, 255)	1
Audio Gain	(0, 255)	0
L Gating	(0, 255)	1

Sub Brightness Adjustment

1. Input a Monoscope pattern.
2. Press 'TEST' 'TEST' 13 on the Remote Commander.
3. Adjust the 'Sub-Brightness' data so that there is barely a difference between the 0 IRE and 10 IRE signal levels.

Sub Contrast Adjustment

1. Input a video signal that contains a small 100% white area on a black background.
2. Connect an digital voltmeter to Pin 10 of J701 [C Board].
3. Adjust the Sub-Contrast ['TT11'] to obtain a voltage of 95 +0,- 5V.

Sub Colour Adjustment

1. Receive a PAL colour bar signal.
2. Connect an oscilloscope to Pin 3 of CN504 [A Board].
3. Enter into the 'Service' service menu.
4. Adjust the 'Sub Colour' data so that the Cyan, Magenta and Blue colour bars are of equal levels as indicated below.

Note:

Ensure that no signal is applied to the Antenna socket while carrying out the following IF adjustments.

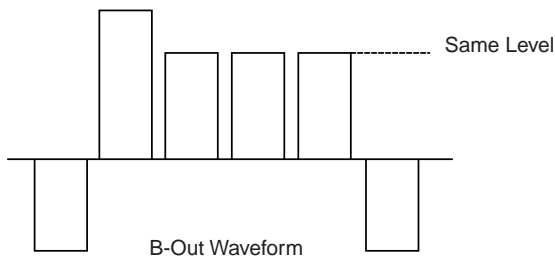

Tuner AGC Adjustment

1. Set the "AGC adjust" register value :
 - For destination France set the value to 6.
 - All other destinations set the value to 0.
2. Receive a signal of 64dBuV / 75 ohm terminated [62dBuV / 75 ohms for B model] via the tuner antenna socket.
3. Connect a voltmeter to pin1 of TU101 [print side of A Board] or to the AGC pin of CN001 [mount side of A Board].
4. Confirm that the AGC voltage is 3.5volts +/- 0.3volts.
5. If adjustment is required, enter into the 'Test Menu'.
6. Select the 'AGC Adjust' menu item.
7. Adjust the data using the left and right arrow buttons on the Remote Commander to obtain a voltage of 3.5V +/- 0.3V.

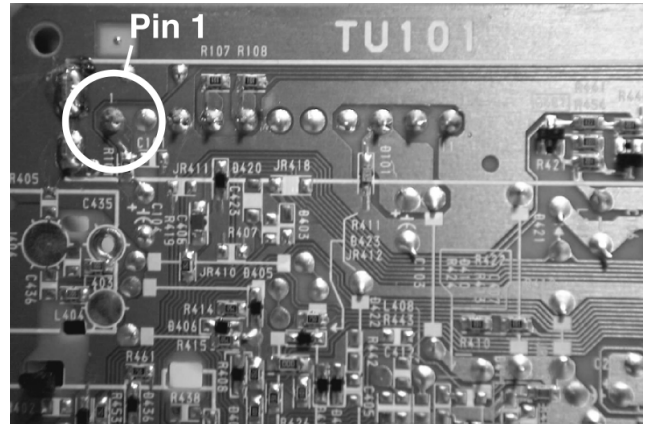

[Print side of A board]

Deflection System Adjustment

1. Enter into the 'Geometry' service menu.
2. Select and adjust each item in order to obtain the optimum image.

GEOMETRY

Left-HBlk	(0, 15)	13
Right-HBlk	(0, 15)	9
V-Angle	(0, 63)	Adj
V-Bow	(0, 63)	Adj
H-Centre	(0, 63)	Adj
H-Size	(0, 63)	Adj
Pin-Amp	(0, 63)	Adj
U-Corner-Pin	(0, 63)	Adj
L-Corner-Pin	(0, 63)	Adj
Pin Phase	(0, 63)	Adj
V-Linearity	(0, 63)	Adj
V-Size	(0, 63)	Adj
S-Correction	(0, 63)	Adj
V-Centre	(0, 63)	Adj
V-Zoom	(0, 63)	25

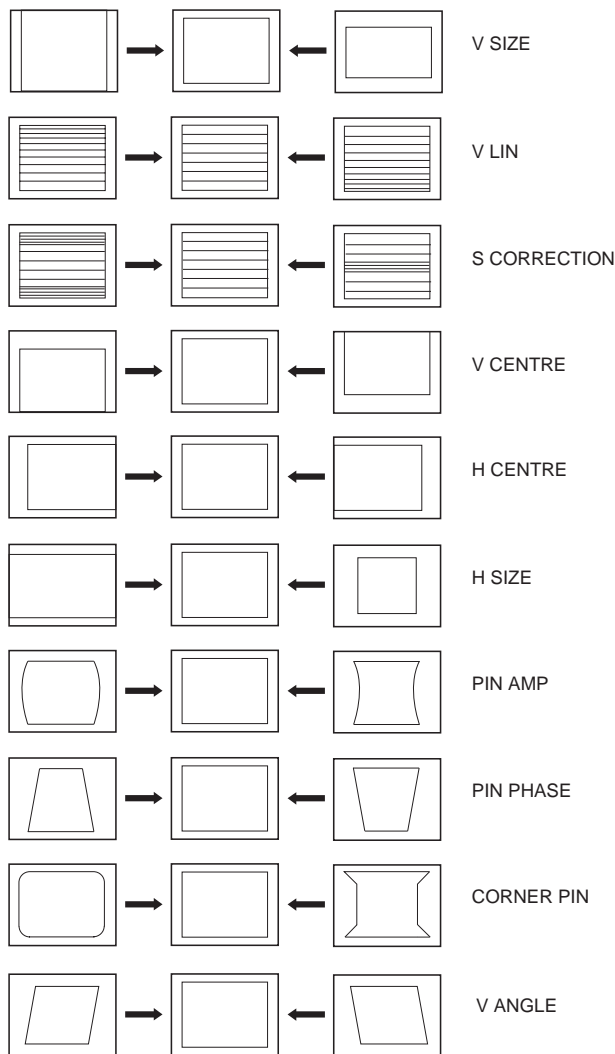

4-2. TEST MODE 2:

Is available by pressing the 'TEST' button twice, OSD 'TT' appears. The functions described below are available by selecting the two numbers. To release the 'Test mode 2', press 00, 10, 20 ... twice or switch the TV set into Stand-by mode. In 'TT Menu' mode, it is possible to remove the Menu from the screen by pressing the Speaker Off button once. Pressing the Speaker OFF button a second time will cause the Menu to reappear. The function is kept even when the menu is not displayed on screen !!.

00	'TT' mode off
01	Picture maximum
02	Picture minimum
03	Set speaker/headphone Volume to 35%
04	Set speaker/headphone Volume to 50%
05	Set speaker/headphone Volume to 65%
06	Set speaker/headphone Volume to 80%
07	Ageing mode
08	Shipping Condition
11	Sub picture adjustment
12	Sub colour adjustment
13	Sub Brightness adjustment
14	Text H Position adjustment
15	Picture Rotation Test
16	Picture level 50%
19	Toggle Factory Mode
21	Destination ADE
22	Destination BL
23	Destination ADE
24	Destination U
25	Destination ADE
26	Destination BL
27	Destination KR
28	Destination KR
31	Auto Sutoff Disable/Enable
33	Rotation ON/OFF
35	No Function
36	No Function
38	Enter G2 Adjustment
41	Re-initialise NVM (Prog 59)
42	Re-initialise geometry (Prog 59)
48	Set NVM as non virgin (Prog 59)
49	Set NVM as virgin (Prog 59)
61	Auto AGC adjustment
63	No Function
64	Enable/disable RGB priority
65	RGB auto-detect enable/disable
66	On timer enable/disable
67	Manual AGC adjustment
68	Enable/disable X26 countermeasure (N problem)
71	Force PAL video (Factory Use Only)
72	Un-force PAL(restore normal video condition)
87	Local keys test
88	No Function
89	Enable/disable watchdog
99	Display Error and Working Time menu

5-2. CIRCUIT BOARD LOCATION

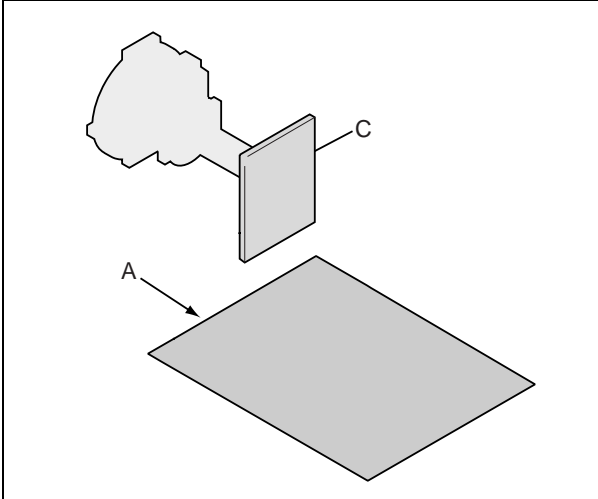









5-3. SCHEMATIC DIAGRAMS AND PRINTED WIRING BOARDS

Note :

- All capacitors are in μF unless otherwise noted.
- pF : μF 50WV or less are not indicated except for electrolytic types.
- Indication of resistance, which does not have one for rating electrical power, is as follows.

Pitch : 5mm
Electrical power rating : 1/4W

- Chip resistors are 1/10W
- All resistors are in ohms.
k = 1000 ohms, M = 1000,000 ohms
-  : nonflammable resistor.
-  : fusible resistor.
-  : internal component.
-  : panel designation or adjustment for repair.
- All variable and adjustable resistors have characteristic curve B, unless otherwise noted.
- All voltages are in Volts.
- Readings are taken with a 10Mohm digital mutimeter.
- Readings are taken with a color bar input signal.
- Voltage variations may be noted due to normal production tolerences.
-  : B + bus.
-  : B - bus.
-  : RF signal path.
-  : earth - ground.
-  : earth - chassis.

Reference Information

RESISTOR	RN	: METAL FILM
	RC	: SOLID
	FPRD	: NON FLAMMABLE CARBON
	FUSE	: NON FLAMMABLE FUSIBLE
	RS	: NON FLAMMABLE METAL OXIDE
	RB	: NON FLAMMABLE CEMENT
	RW	: NON FLAMMABLE WIREWOUND
		: ADJUSTMENT RESISTOR
COIL	LF-8L	: MICRO INDUCTOR
CAPACITOR	TA	: TANTALUM
	PS	: STYROL
	PP	: POLYPROPYLENE
	PT	: MYLAR
	MPS	: METALIZED POLYESTER
	MPP	: METALIZED POLYPROPYLENE
	ALB	: BIPOLAR
	ALT	: HIGH TEMPERATURE
	ALR	: HIGH RIPPLE

Note : The components identified by shading and marked  are critical for safety. Replace only with the part numbers specified in the parts list.

Note : Les composants identifiés par une trame et par une marque  sont d'une importance critique pour la sécurité. Ne les remplacer que par des pièces de numéro spécifié.

5-2. BLOCK DIAGRAMS (1)

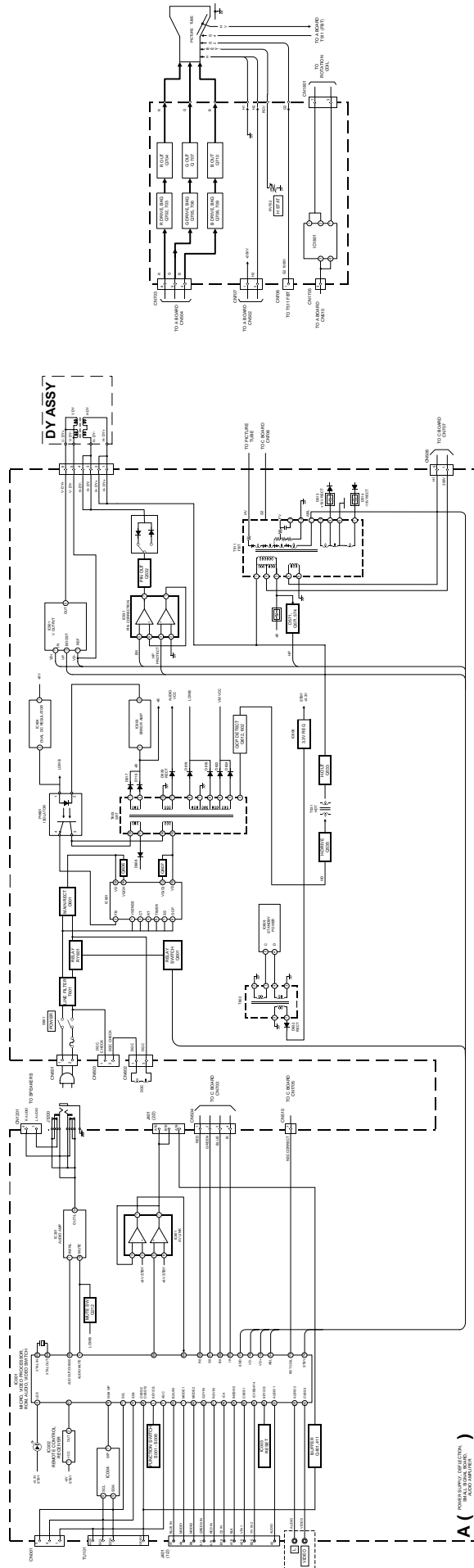

C [R. & B OUT]

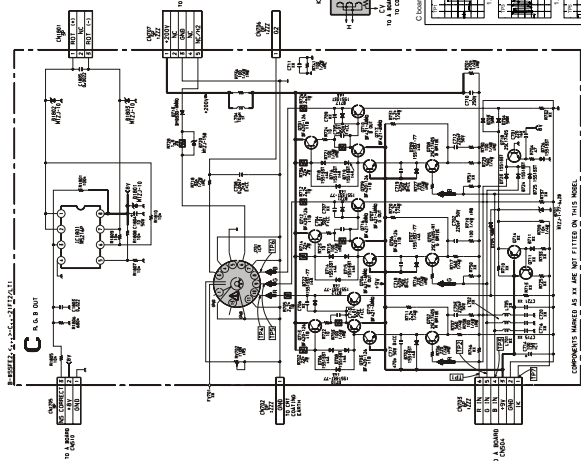

C Board Semiconductor Voltage Table

Part No.	Part No.	Part No.	Part No.	Part No.	Part No.	Part No.	Part No.
0001	0002	0003	0004	0005	0006	0007	0008
0009	0010	0011	0012	0013	0014	0015	0016
0017	0018	0019	0020	0021	0022	0023	0024
0025	0026	0027	0028	0029	0030	0031	0032
0033	0034	0035	0036	0037	0038	0039	0040
0041	0042	0043	0044	0045	0046	0047	0048
0049	0050	0051	0052	0053	0054	0055	0056
0057	0058	0059	0060	0061	0062	0063	0064
0065	0066	0067	0068	0069	0070	0071	0072
0073	0074	0075	0076	0077	0078	0079	0080
0081	0082	0083	0084	0085	0086	0087	0088
0089	0090	0091	0092	0093	0094	0095	0096
0097	0098	0099	0100	0101	0102	0103	0104
0105	0106	0107	0108	0109	0110	0111	0112
0113	0114	0115	0116	0117	0118	0119	0120
0121	0122	0123	0124	0125	0126	0127	0128
0129	0130	0131	0132	0133	0134	0135	0136
0137	0138	0139	0140	0141	0142	0143	0144
0145	0146	0147	0148	0149	0150	0151	0152
0153	0154	0155	0156	0157	0158	0159	0160
0161	0162	0163	0164	0165	0166	0167	0168
0169	0170	0171	0172	0173	0174	0175	0176
0177	0178	0179	0180	0181	0182	0183	0184
0185	0186	0187	0188	0189	0190	0191	0192
0193	0194	0195	0196	0197	0198	0199	0200

[C PRINTED WIRING BOARD]

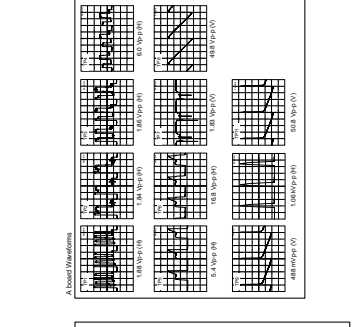
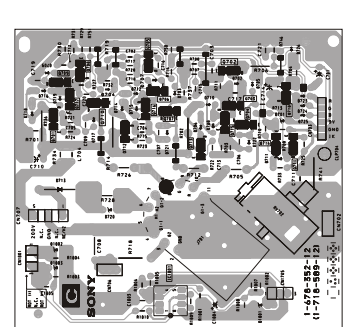

[A PRINTED WIRING BOARD]

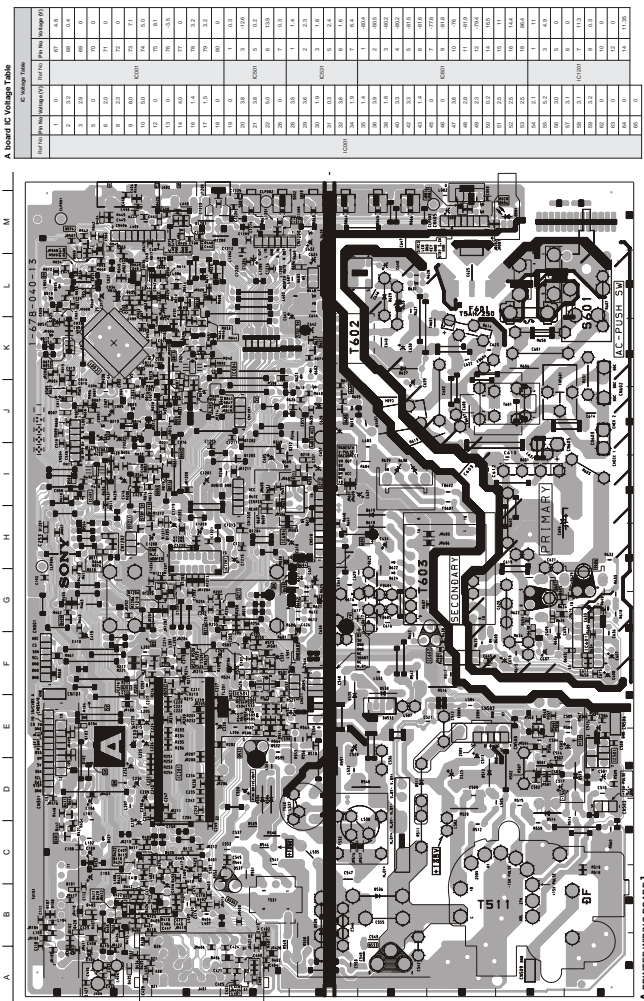

A Board IC Voltage Table

Part No.	Part No.	Part No.	Part No.	Part No.	Part No.	Part No.	Part No.
0001	0002	0003	0004	0005	0006	0007	0008
0009	0010	0011	0012	0013	0014	0015	0016
0017	0018	0019	0020	0021	0022	0023	0024
0025	0026	0027	0028	0029	0030	0031	0032
0033	0034	0035	0036	0037	0038	0039	0040
0041	0042	0043	0044	0045	0046	0047	0048
0049	0050	0051	0052	0053	0054	0055	0056
0057	0058	0059	0060	0061	0062	0063	0064
0065	0066	0067	0068	0069	0070	0071	0072
0073	0074	0075	0076	0077	0078	0079	0080
0081	0082	0083	0084	0085	0086	0087	0088
0089	0090	0091	0092	0093	0094	0095	0096
0097	0098	0099	0100	0101	0102	0103	0104
0105	0106	0107	0108	0109	0110	0111	0112
0113	0114	0115	0116	0117	0118	0119	0120
0121	0122	0123	0124	0125	0126	0127	0128
0129	0130	0131	0132	0133	0134	0135	0136
0137	0138	0139	0140	0141	0142	0143	0144
0145	0146	0147	0148	0149	0150	0151	0152
0153	0154	0155	0156	0157	0158	0159	0160
0161	0162	0163	0164	0165	0166	0167	0168
0169	0170	0171	0172	0173	0174	0175	0176
0177	0178	0179	0180	0181	0182	0183	0184
0185	0186	0187	0188	0189	0190	0191	0192
0193	0194	0195	0196	0197	0198	0199	0200

A Board Location Table

Part No.	Part No.	Part No.	Part No.	Part No.	Part No.	Part No.	Part No.
0001	0002	0003	0004	0005	0006	0007	0008
0009	0010	0011	0012	0013	0014	0015	0016
0017	0018	0019	0020	0021	0022	0023	0024
0025	0026	0027	0028	0029	0030	0031	0032
0033	0034	0035	0036	0037	0038	0039	0040
0041	0042	0043	0044	0045	0046	0047	0048
0049	0050	0051	0052	0053	0054	0055	0056
0057	0058	0059	0060	0061	0062	0063	0064
0065	0066	0067	0068	0069	0070	0071	0072
0073	0074	0075	0076	0077	0078	0079	0080
0081	0082	0083	0084	0085	0086	0087	0088
0089	0090	0091	0092	0093	0094	0095	0096
0097	0098	0099	0100	0101	0102	0103	0104
0105	0106	0107	0108	0109	0110	0111	0112
0113	0114	0115	0116	0117	0118	0119	0120
0121	0122	0123	0124	0125	0126	0127	0128
0129	0130	0131	0132	0133	0134	0135	0136
0137	0138	0139	0140	0141	0142	0143	0144
0145	0146	0147	0148	0149	0150	0151	0152
0153	0154	0155	0156	0157	0158	0159	0160
0161	0162	0163	0164	0165	0166	0167	0168
0169	0170	0171	0172	0173	0174	0175	0176
0177	0178	0179	0180	0181	0182	0183	0184
0185	0186	0187	0188	0189	0190	0191	0192
0193	0194	0195	0196	0197	0198	0199	0200



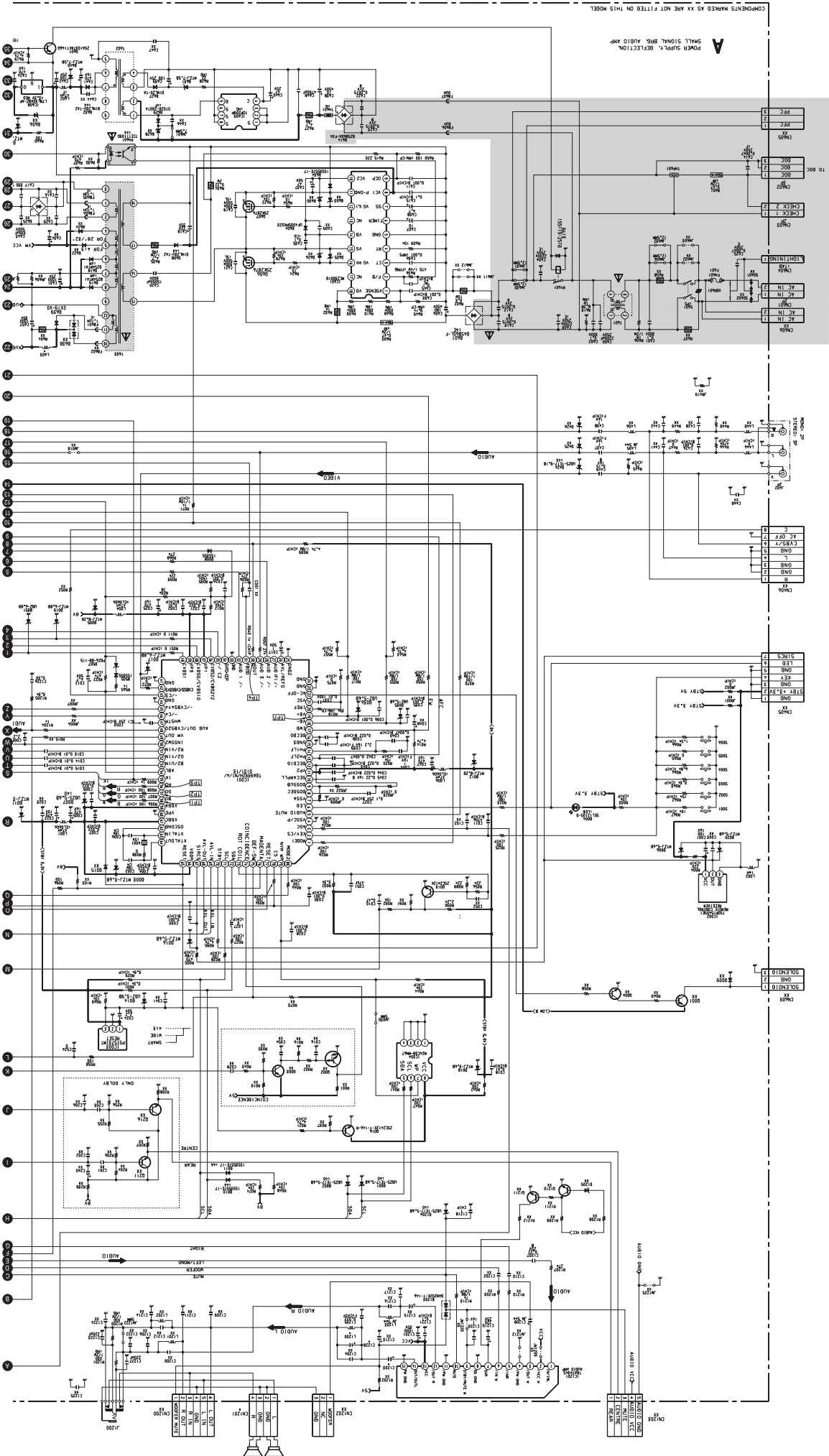

REF	KVZL1TU	KVZL1TE	KVZL1TK	KVZL1TU	KVZL1TK	KVZL1TU	KVZL1TK
C1200	1000P	1000P	1000P	1000P	1000P	2000F	2000F
CN101	PLUG, CONNECTOR 3P	PLUG, CONNECTOR 3P	PLUG, CONNECTOR 3P	PLUG, CONNECTOR 3P	PLUG, CONNECTOR 3P	CONNECTOR 3P	CONNECTOR 3P
L1000	JW 5.0mm	JW 5.0mm	JW 5.0mm	JW 5.0mm	JW 5.0mm	JW 5.0mm	JW 5.0mm
TU101	BT-F-EP41	BT-F-EP41	BT-F-EP41	BT-F-EP41	BT-F-EP41	BT-F-EP41	BT-F-EP41

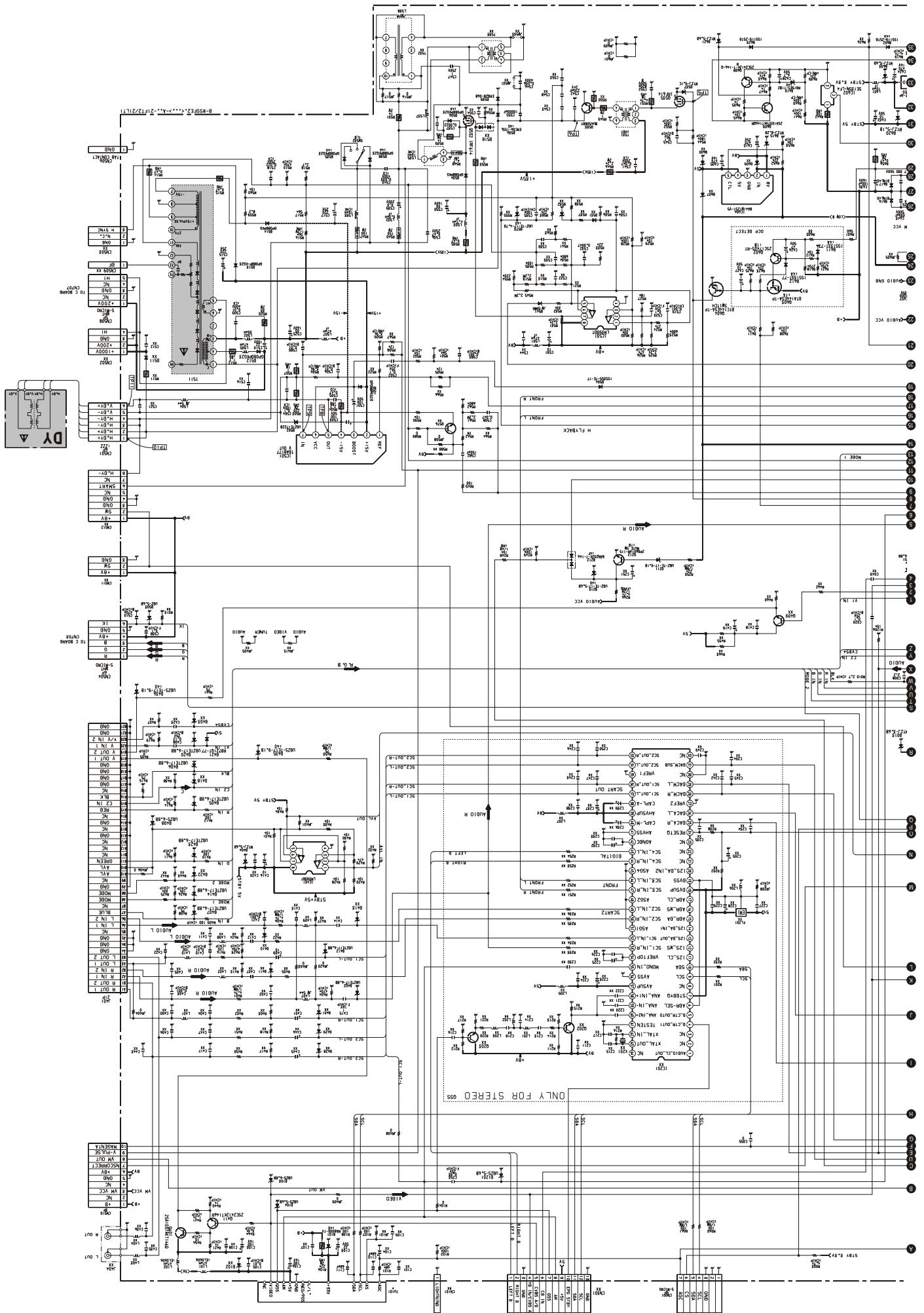

10 C BOARD

10 C BOARD

10 C BOARD

10 C BOARD

10 C BOARD

ONLY FOR STEREO

5-4. SEMICONDUCTORS

LM393DT
TDA2822M
TEA2124

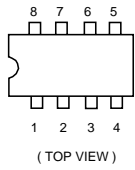

SE-135N
SE135N-LF12

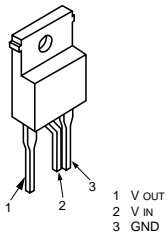

TDA9392H

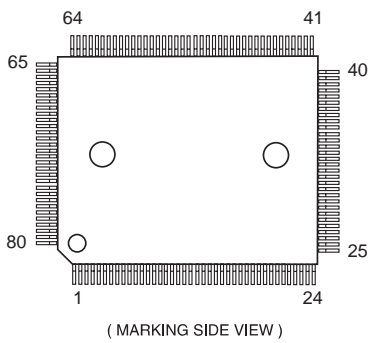

TOP209P

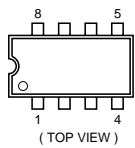

BF421-AMMO
2SA1091-O

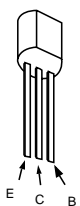

DTA144ESA
DTA144ESA-TP
DTC114EKA
DTC114EKA-T146
DTC143TKA-T146
DTC144EKA-T-146R
2SA1037K-T-146-R
R2SA1162-G
2SA1037K-T-146-QR
2SD601A-QTX
2SC1623-L5-L6
2SC2412K-QR
2SC2412K-T-146-R

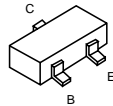

IRF614-LF

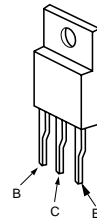

2SA933AS-QRT
2SAG33ASQT
2SA933AS-RT
2SC1740S-RT

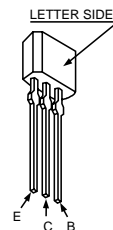

2SK2251-01-F19

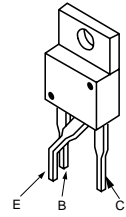

AK04-V1	ERD28-06S
AU-01Z-V1	ERC06-15SL
BYD33G	FMN-G12S
BYD33G-AMMO	GP08DPKG23
DINL20-U-TA2	RG1CLF-B1
DINL40-U-TR2	RGP10GPKG23
ERB44-06TP1	RU-3AM
EGP20G	RU3YX-LF-C4
EG-1Z-V1	RU3YX-V1
EL1Z	RU-4AM-T3
ERD28-06S	1SS292T-77

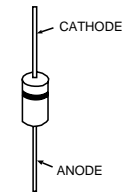

DAN202K
DAN202K-T146

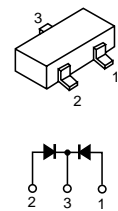

D4SB60L-F

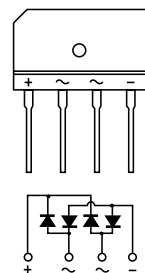

2SC2785-HFE

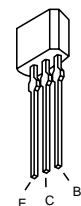

ERA81-004TP1	MTZJ-T-77-15B
ERA83-006	MTZJ-T-77-33A
MTZJ-3.6A	MTZJ-33C
MTZJ-T-77-2.2A	MTZJ-7.5B
HZS9.INBZ	RD3.9ES-B2
MTZJ-T-77-3.6B	RD5.6ESB2
MTZJ-T-77-5.6B	RD6.8ES-B2
MTZJ-T-77-5.6C	RD7.5ESB2
MTZJ-T-77-6.8A	RD9.1ES-B3
MTZJ-T-77-6.8C	RD10ESB2
MTZJ-T-77-8.2B	RD15ESB2
MTZJ-T-77-7.5B	1SS119-25TD
MTZJ-T-77-9.1A	1SS133T-77
MTZJ-T-77-9.1C	
MTZJ-T-77-10	

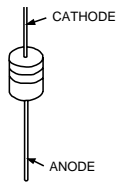

SLA-570KT3F

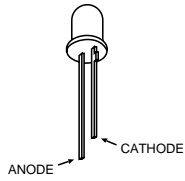

1SS355TE-17
 RD12SB2
 UDZS-TE-17-4.7B
 UDZS-TE-17-5.6B
 UDZS-TE-17-6.8B
 UDZS-TE-17-9.1B
 UDZ-TE-17-22B

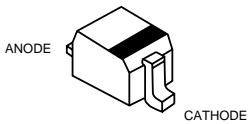

UF4005PKG23

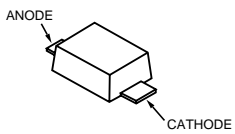

5-5 IC BLOCK DIAGRAMS

A BOARD IC604 BA41W12ST

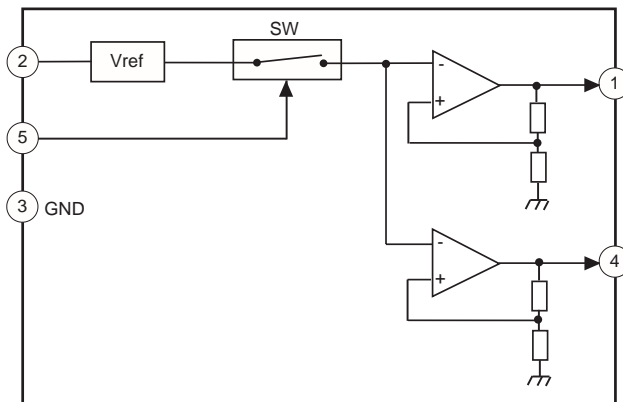

A BOARD IC401/IC531 LM393TD

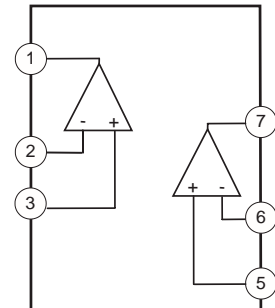

A BOARD IC601 MCZ3001D

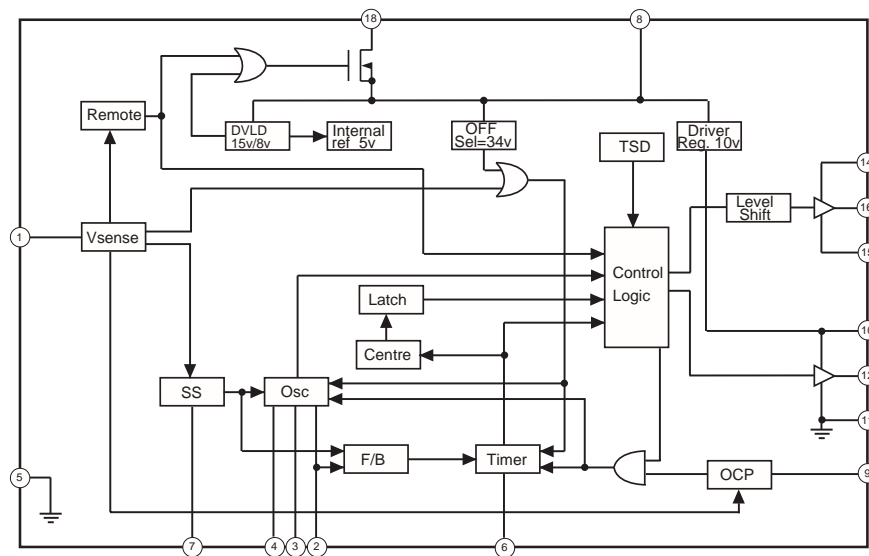

A BOARD IC1201 TDA7494

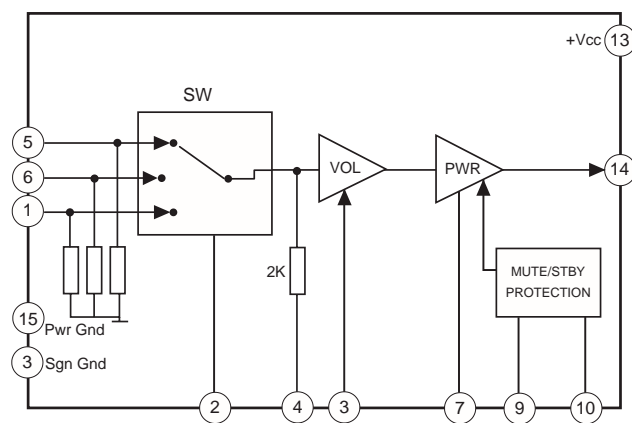

SECTION 6 EXPLODED VIEWS

Note : Les composants identifiés par une trame et par une marque Δ sont d'une importance critique pour la sécurité. Ne les remplacer que par des pièces du numéro spécifié.

Note : The components identified by shading and marked Δ are critical for safety. Replace only with the part numbers specified in the parts list.

NOTE :

- Items with no part number and no description are not stocked because they are seldom required for routine service.
- The construction parts of an assembled part are indicated with a collation number in the remarks column.
- Items marked “*” are not stocked since they are seldom required for routine service. Some delay should be anticipated when ordering these items.

6-1. KV-21LT1 CHASSIS

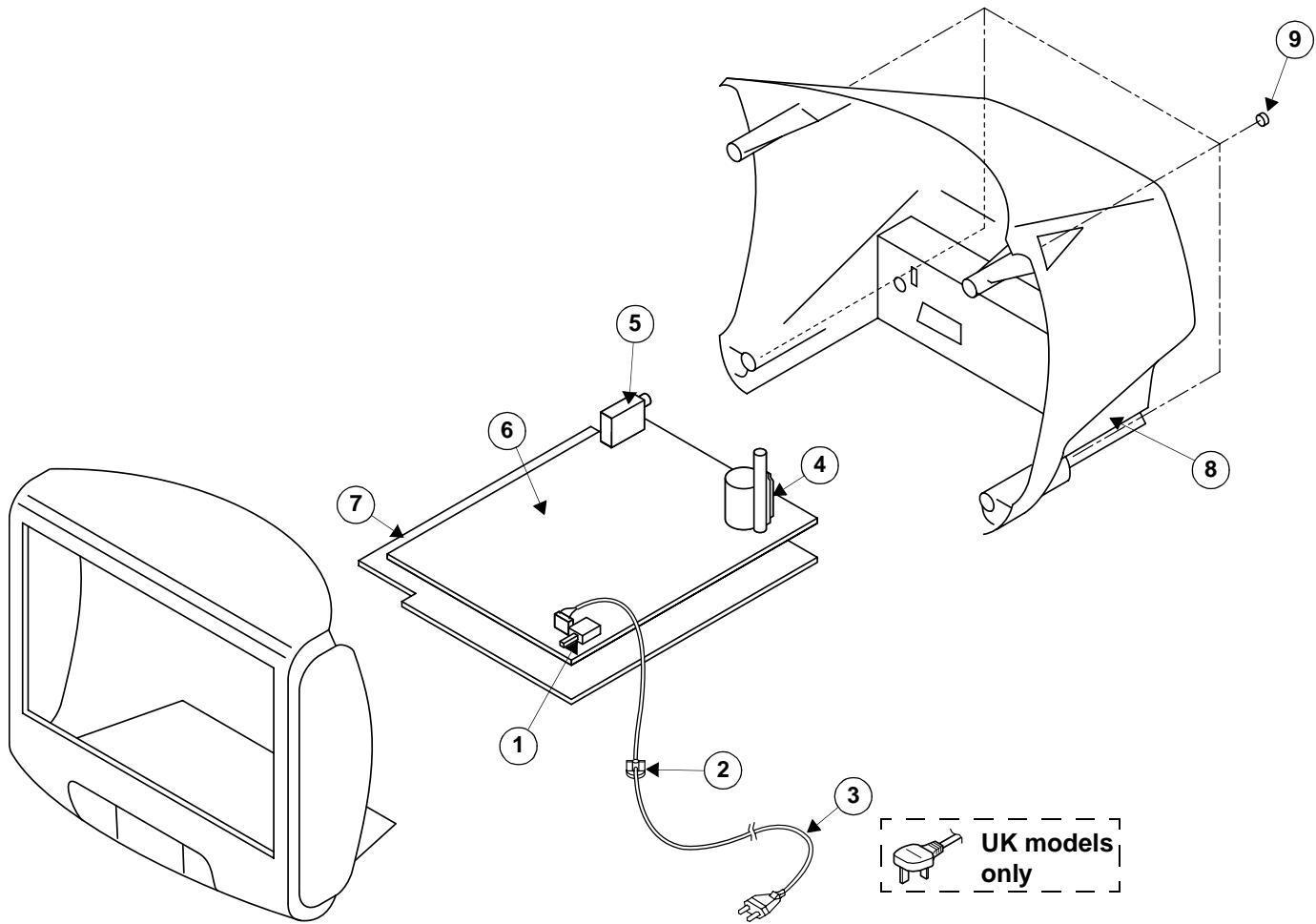

REF. NO.	PART.NO	DESCRIPTION	REMARK	REF. NO.	PART.NO	DESCRIPTION	REMARK
1	Δ 1-571-433-21	SWITCH, PUSH (AC POWER)		6	*A-1632-893-A	A BOARD, COMPLETE (KV-21LT1B)	
2	*4-202-531-01	AC CORD LOCK (SC)			*A-1632-880-A	A BOARD, COMPLETE (KV-21LT1E)	
3	Δ 1-765-286-11	CORD, POWER (KV-21LT1B/21LT1E/21LT1K)			*A-1632-892-A	A BOARD, COMPLETE (KV-21LT1K)	
	Δ 1-776-860-11	POWER CORD, FILTER (KV-21LT1U)			*A-1632-894-A	A BOARD, COMPLETE (KV-21LT1U)	
4	Δ 1-453-345-11	TRANSFORMER ASSY, FLYBACK (NX1748//M3A4)		7	*4-204-143-02	BRACKET, MAIN	
5	8-598-535-00	FRONTEND BTF-EF411 (KV-21LT1B)		8	4-205-362-01	REAR COVER	
	8-598-531-00	FRONTEND BTF-EC401 (KV-21LT1E)		9	7-685-663-71	SCREW +BVTP 4X16 TYPE 2 IT-3	
	8-598-537-00	FRONTEND BTF-EP401 (KV-21LT1K)					
	8-598-527-00	FRONTEND BTF-EU601 (KV-21LT1U)					

6-2. KV-21LT1 PICTURE TUBE

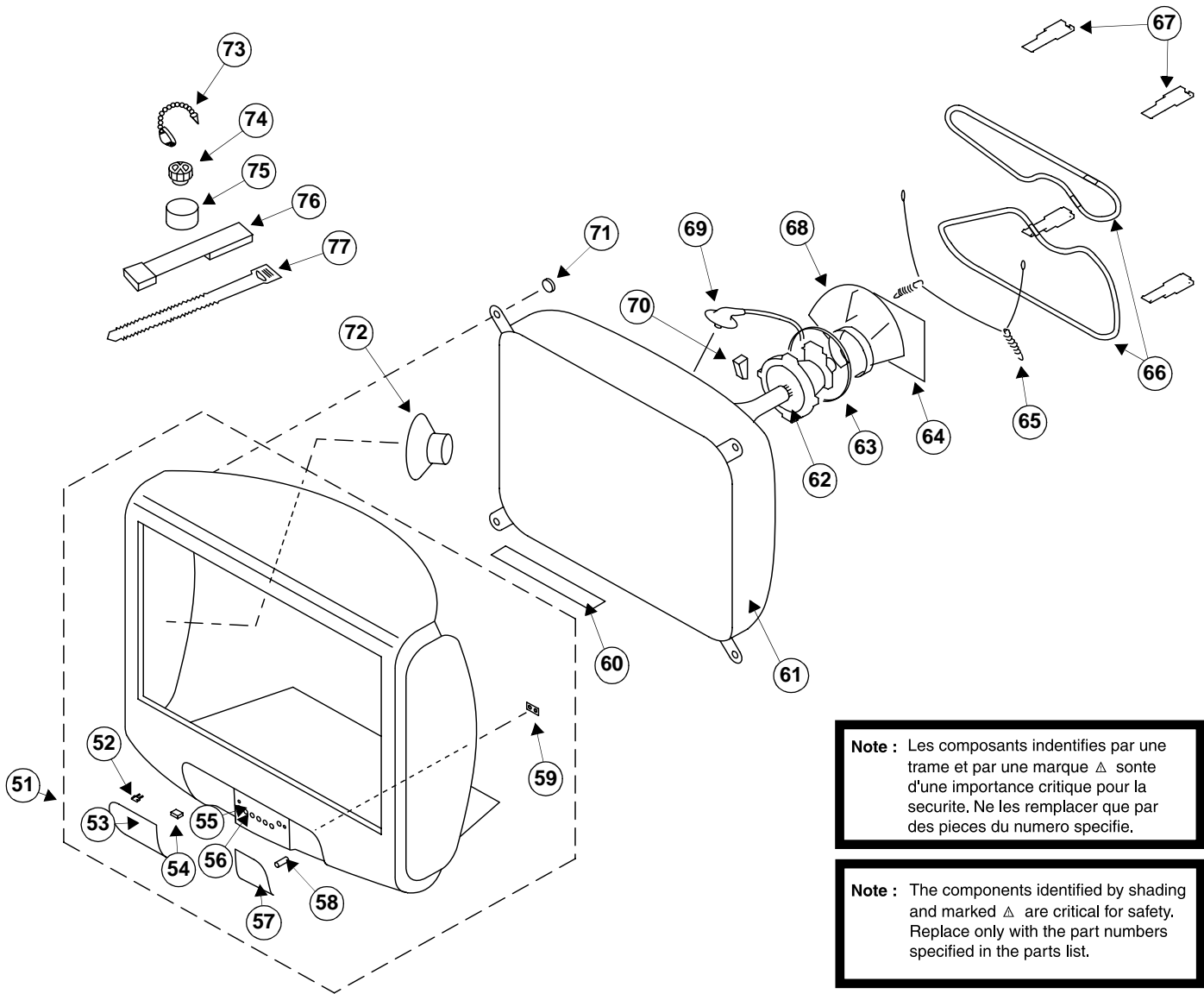

REF. NO.	PART. NO	DESCRIPTION	REMARK	REF. NO.	PART. NO	DESCRIPTION	REMARK
51	X-4200-621-1	BEZNET ASSY	52-59	65	4-369-318-21	SPRING, TENSION	
52	4-047-464-01	CATCHER, PUSH		66	Δ 1-419-187-11	COIL, DEGAUSSING	
53	4-205-364-01	DOOR		67	*4-204-900-01	BAND, DGC	
54	4-205-365-01	SHAFT DOOR		68	*4-202-554-01	HOLDER, HV CABLE	
55	4-205-376-01	MULTI BUTTON		69	Δ 1-251-839-21	CAP ASSY, HIGH VOLTAGE	
56	4-205-550-01	COVER MULTI BUTTON		70	3-704-495-01	SPACER, DY	
57	4-205-363-01	BUTTON, POWER		71	4-365-808-01	SCREW (5), TAPPING	
58	4-204-426-01	SPRING		72	1-529-711-11	SPEAKER, (8CM)	
59	4-205-375-01	GUIDE, LIGHT		73	4-308-870-00	CLIP, LEAD WIRE	
60	4-204-666-01	SHEET, BLOTTING		74	1-452-094-00	MAGNET, ROTATABLE DISK; 15MM \varnothing	
61	Δ 8-738-836-05	PICTURE TUBE (A51LPT60X) (SD-313)		75	1-452-032-00	MAGNET, DISK; 10MM \varnothing	
62	Δ 8-451-505-11	DEFLECTION YOKE (Y21RSA-S)		76	X-4387-214-1	PERMALLOY ASSY, CORRECTION	
63	1-452-728-61	COIL, NA ROTATION (RT-154)		77	3-701-007-00	BAND, BINDING	
64	*A-1639-004-A	C BOARD, COMPLETE					

SECTION 6 EXPLODED VIEWS

NOTE :

- Items with no part number and no description are not stocked because they are seldom required for routine service.
- The construction parts of an assembled part are indicated with a collation number in the remarks column.
- Items marked “ * ” are not stocked since they are seldom required for routine service. Some delay should be anticipated when ordering these items.

Note : Les composants identifiés par une trame et par une marque Δ sont d'une importance critique pour la sécurité. Ne les remplacer que par des pièces du numéro spécifié.

Note : The components identified by shading and marked Δ are critical for safety. Replace only with the part numbers specified in the parts list.

6-3. KV-21FT2 CHASSIS

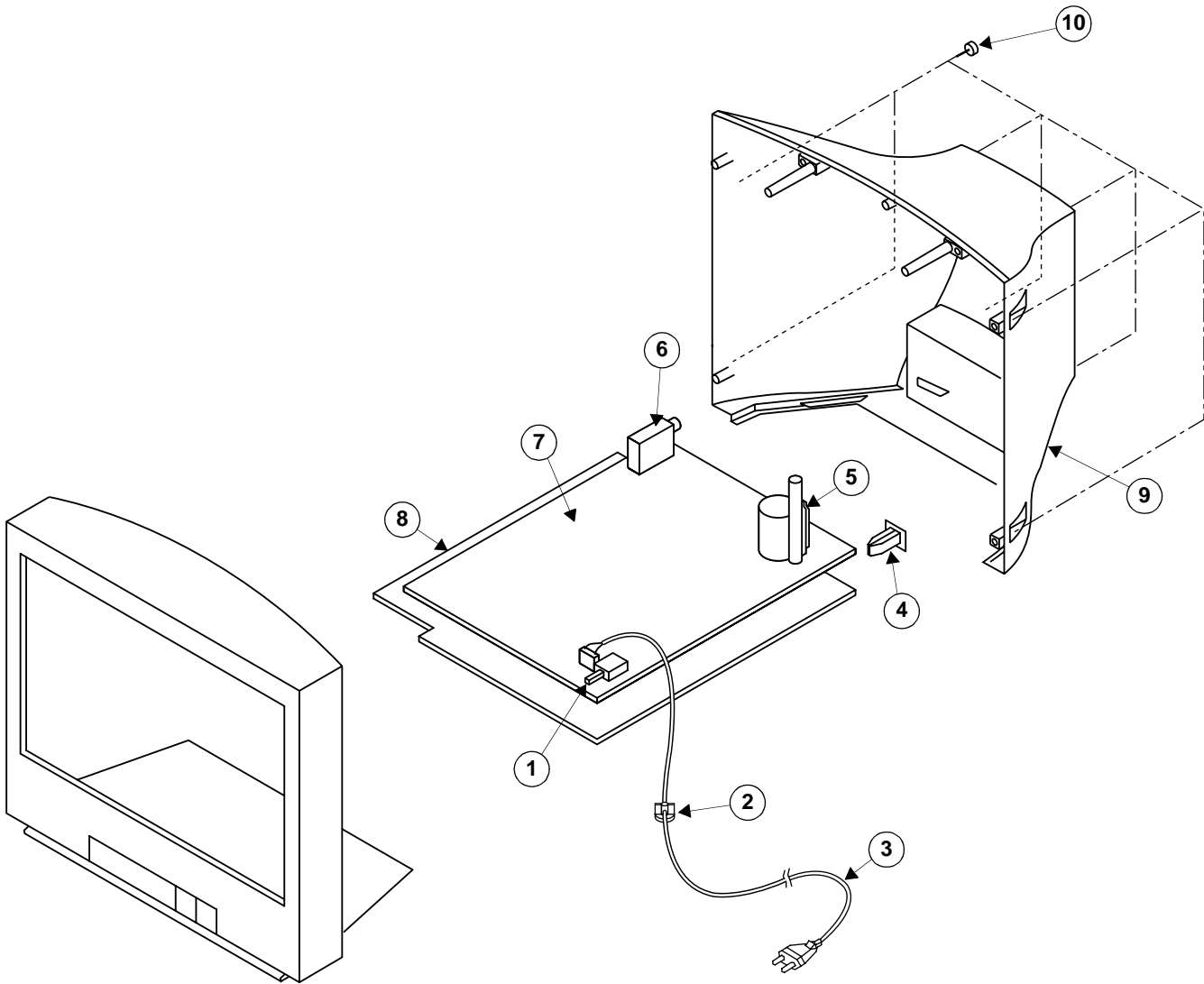

REF. NO.	PART. NO	DESCRIPTION	REMARK	REF. NO.	PART. NO	DESCRIPTION	REMARK
1	Δ 1-571-433-21	SWITCH, PUSH (AC POWER)		6	8-598-537-00	FRONTEND BTF-EP401	
2	*4-202-531-01	AC CORD LOCK (SC)		7	*A-1632-898-A	A BOARD, COMPLETE	
3	Δ 1-765-286-11	CORD, POWER		8	*4-204-143-11	BRACKET, MAIN	
4	*4-204-517-03	SUPPORT, FBT		9	4-205-399-01	REAR COVER	
5	Δ 1-453-345-11	TRANSFORMER ASSY, FLYBACK (NX1748//M3A4)		10	7-685-663-71	SCREW +BVTP 4X16 TYPE 2 IT-3	

6-4. KV-21FT2 PICTURE TUBE

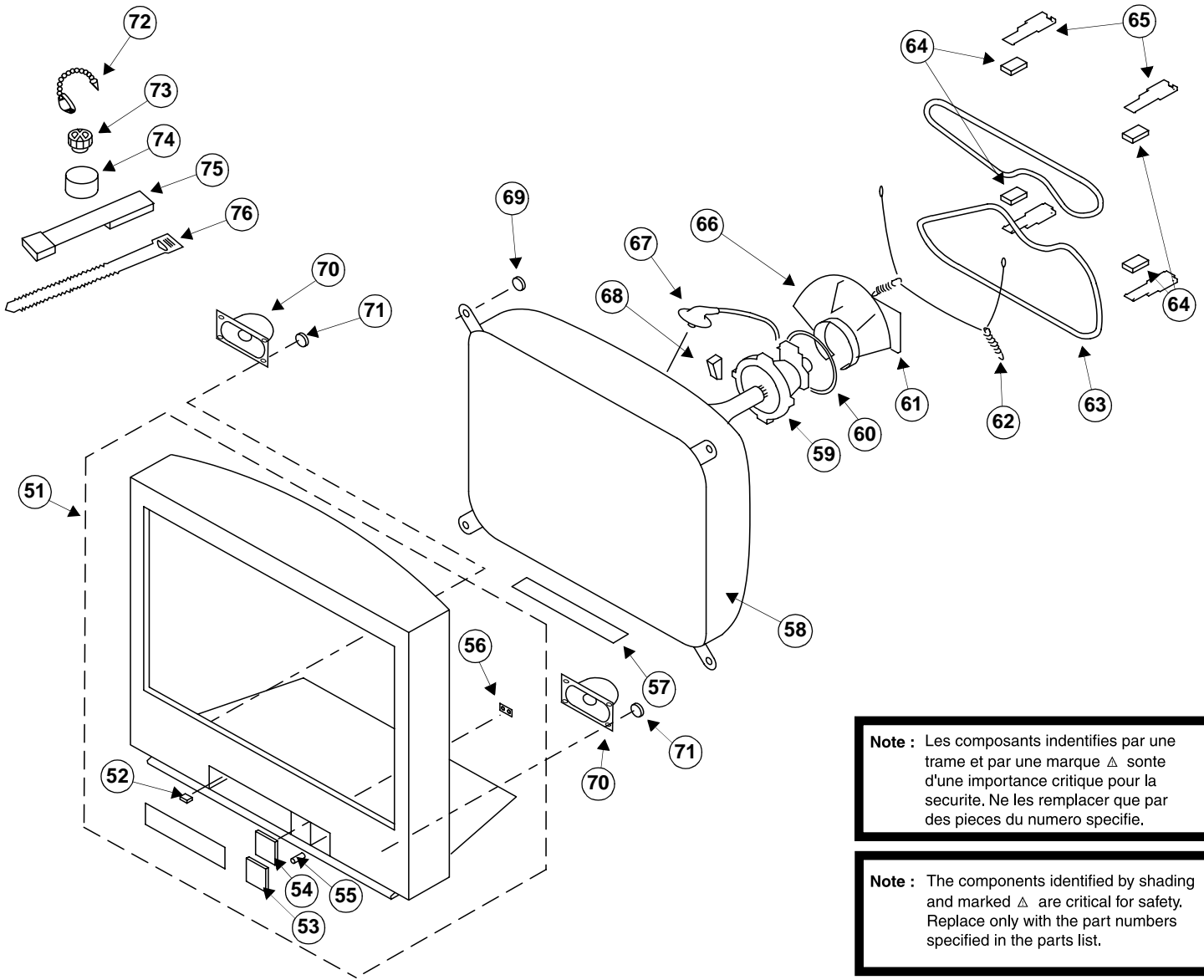

Note : Les composants indentifiés par une trame et par une marque Δ sont d'une importance critique pour la securite. Ne les remplacer que par des pieces du numero specifie.

Note : The components identified by shading and marked Δ are critical for safety. Replace only with the part numbers specified in the parts list.

REF. NO.	PART.NO	DESCRIPTION	REMARK	REF. NO.	PART.NO	DESCRIPTION	REMARK
51	X-4200-622-1	BEZNET ASSY (KV-21LT1)	52-56	64	4-203-390-11	CUSHION, DGC	
52	4-205-398-01	SPRING, DOOR		65	4-204-900-01	BAND, DGC	
53	4-205-396-11	BUTTON, POWER (BARE)		66	4-202-554 01	HOLDER, HV CABLE	
54	4-205-392-11	WINDOW ORNAMENTAL (BARE)		67	Δ 1-251-839-21	CAP ASSY, HIGH VOLTAGE	
55	4-204-426-01	SPRING		68	3-704-495-01	SPACER, DY	
56	4-205-389-01	GUIDE, LIGHT		69	4-365-808-01	SCREW (5), TAPPING	
57	4-204-666-01	SHEET, BLOTTING		70	1-529-710-11	SPEAKER, (5X9CM)	
58	Δ 8-738-836-05	PICTURE TUBE (A51LPT60X) (SD-313)		71	7-685-648-79	SCREW +BVTP 3X12 TYPE 2 IT-3	
59	Δ 8-451-505-11	DEFLECTION YOKE (Y21RSA-S)		72	4-308-870-00	CLIP, LEAD WIRE	
60	1-452-728-61	COIL, NA ROTATION (RT-154)		73	1-452-094-00	MAGNET, ROTATABLE DISK; 15MM \varnothing	
61	*A-1639-004-A	C BOARD, COMPLETE		74	1-452-032-00	MAGNET, DISK; 10MM \varnothing	
62	4-369-318-21	SPRING, TENSION		75	X-4387-214-1	PERMALLOY ASSY, CORRECTION	
63	Δ 1-419-187-11	COIL, DEGAUSSING		76	3-701-007-00	BAND, BINDING	

SECTION 7 ELECTRICAL PARTS LIST

PARTS LISTING TABLE OF CONTENTS

	<u>Page</u>
A BOARD COMMON Parts List : Parts common to all models listed in this manual	47
A BOARD VARIANT Parts List : Parts that belong only to the model specified	
<u>Model</u>	
KV-21LT1	53
KV-21FT2	53
C BOARD COMPLETE Parts List :	53
MISCELLANEOUS :	55
ACCESSORIES AND PACKAGING MATERIALS :	55

Note : Refer to the designated variant parts list when seeking a part indicated by an asterisk (*)
 Parts indicated (#) on the Schematic Diagram are not used in this model and therefore do not appear in the Parts List.

REF. NO.	PART.NO	DESCRIPTION	REMARK	REF. NO.	PART.NO	DESCRIPTION	REMARK
*A-1632-893-A A Board, Complete (KV-21LT1B) *A-1632-880-A A Board, Complete (KV-21LT1E) *A-1632-892-A A Board, Complete (KV-21LT1K) *A-1632-894-A A Board, Complete (KV-21LT1U) *A-1632-898-A A Board, Complete (KV-21FT2K)				C044	1-164-346-11	CERAMIC CHIP 1UF	16V
				C045	1-164-489-11	CERAMIC CHIP 0.22UF	10.00% 16V
				C046	1-163-037-11	CERAMIC CHIP 0.022UF	10.00% 50V
				C047	1-126-935-11	ELECT 470UF	20.00% 16V
				C051	1-163-109-00	CERAMIC CHIP 47PF	5.00% 50V
A Board, Common Parts				C053	1-164-004-11	CERAMIC CHIP 0.1UF	10.00% 25V
	4-203-258-01	HOLDER, LED		C055	1-216-295-91	SHORT 0	
	*4-374-846-01	COVER, CAPACITOR, CAP TYPE		C100	1-126-933-11	ELECT 100UF	20.00% 16V
	4-382-854-01	SCREW (M3X8), P, SW (+)		C103	1-126-965-11	ELECT 22UF	20.00% 50V
	4-382-854-01	SCREW (M3X8), P, SW (+)		C105	1-163-021-91	CERAMIC CHIP 0.01UF	10.00% 50V
	< CAPACITOR >			C106	1-126-933-11	ELECT 100UF	20.00% 16V
C001	1-126-933-11	ELECT 100UF	20.00% 16V	C110	1-163-113-00	CERAMIC CHIP 68PF	5.00% 50V
C002	1-163-233-11	CERAMIC CHIP 18PF	5.00% 50V	C111	1-163-113-00	CERAMIC CHIP 68PF	5.00% 50V
C004	1-163-037-11	CERAMIC CHIP 0.022UF	10.00% 50V	C253	1-164-336-11	CERAMIC CHIP 0.33UF	25V
C005	1-126-935-11	ELECT 470UF	20.00% 16V	C403	1-163-009-11	CERAMIC CHIP 0.001UF	10.00% 50V
C006	1-163-233-11	CERAMIC CHIP 18PF	5.00% 50V	C408	1-164-348-11	CERAMIC CHIP 0.12UF	10.00% 25V
C007	1-163-037-11	CERAMIC CHIP 0.022UF	10.00% 50V	C409	1-126-964-11	ELECT 10UF	20.00% 50V
C008	1-164-337-11	CERAMIC CHIP 2.2UF	16V	C410	1-163-021-91	CERAMIC CHIP 0.01UF	10.00% 50V
C009	1-163-037-11	CERAMIC CHIP 0.022UF	10.00% 50V	C415	1-164-346-11	CERAMIC CHIP 1UF	16V
C010	1-164-005-11	CERAMIC CHIP 0.47UF	16V	C416	1-126-964-11	ELECT 10UF	20.00% 50V
C011	1-163-005-11	CERAMIC CHIP 470PF	10.00% 50V	C421	1-163-009-11	CERAMIC CHIP 0.001UF	10.00% 50V
C012	1-126-963-11	ELECT 4.7UF	20.00% 50V	C426	1-163-009-11	CERAMIC CHIP 0.001UF	10.00% 50V
C013	1-163-021-91	CERAMIC CHIP 0.01UF	10.00% 50V	C437	1-164-346-11	CERAMIC CHIP 1UF	16V
C014	1-163-021-91	CERAMIC CHIP 0.01UF	10.00% 50V	C438	1-164-346-11	CERAMIC CHIP 1UF	16V
C015	1-163-021-91	CERAMIC CHIP 0.01UF	10.00% 50V	C449	1-164-492-11	CERAMIC CHIP 0.15UF	10.00% 16V
C017	1-126-960-11	ELECT 1UF	20.00% 50V	C501	1-126-968-11	ELECT 100UF	20.00% 50V
C018	1-163-021-91	CERAMIC CHIP 0.01UF	10.00% 50V	C502	1-163-038-91	CERAMIC CHIP 0.1UF	25V
C020	1-164-004-11	CERAMIC CHIP 0.1UF	10.00% 25V	C503	1-126-968-11	ELECT 100UF	20.00% 50V
C021	1-163-037-11	CERAMIC CHIP 0.022UF	10.00% 50V	C504	1-106-220-00	MYLAR 0.1UF	10.00% 100V
C022	1-126-925-11	ELECT 470UF	20.00% 10V	C505	1-137-194-81	MYLAR 0.47UF	5.00% 50V
C024	1-126-961-11	ELECT 2.2UF	20.00% 50V	C506	1-163-021-91	CERAMIC CHIP 0.01UF	10.00% 50V
C025	1-126-935-11	ELECT 470UF	20.00% 16V	C508	1-163-035-00	CERAMIC CHIP 0.047UF	50V
C026	1-163-009-11	CERAMIC CHIP 0.001UF	10.00% 50V	C509	1-107-364-11	MYLAR 0.01UF	10.00% 400V
C027	1-164-004-11	CERAMIC CHIP 0.1UF	10.00% 25V	C510	1-163-005-11	CERAMIC CHIP 470PF	10.00% 50V
C028	1-163-009-11	CERAMIC CHIP 0.001UF	10.00% 50V	C513	1-128-560-11	ELECT 22UF	20.00% 100V
C030	1-163-009-11	CERAMIC CHIP 0.001UF	10.00% 50V	C515	1-104-666-11	ELECT 220UF	20.00% 25V
C032	1-163-021-91	CERAMIC CHIP 0.01UF	10.00% 50V	C517	1-104-666-11	ELECT 220UF	20.00% 25V
C033	1-163-009-11	CERAMIC CHIP 0.001UF	10.00% 50V	C518	1-106-375-12	MYLAR 0.022UF	10.00% 250V
C035	1-163-009-11	CERAMIC CHIP 0.001UF	10.00% 50V	C519	1-163-275-11	CERAMIC CHIP 0.001UF	5.00% 50V
C036	1-163-009-11	CERAMIC CHIP 0.001UF	10.00% 50V	C520	1-163-038-91	CERAMIC CHIP 0.1UF	25V
C037	1-137-354-11	FILM 0.01UF	5.00% 100V	C524	1-216-295-91	SHORT 0	
C038	1-163-037-11	CERAMIC CHIP 0.022UF	10.00% 50V	C525	1-123-024-21	ELECT 33UF	160V
C039	1-164-505-11	CERAMIC CHIP 2.2UF	16V	C531	1-126-964-11	ELECT 10UF	20.00% 50V
C040	1-163-017-00	CERAMIC CHIP 0.0047UF	10.00% 50V	C532	1-163-017-00	CERAMIC CHIP 0.0047UF	10.00% 50V
C042	1-162-625-11	CERAMIC CHIP 0.0047UF	5.00% 50V	C535	1-163-251-11	CERAMIC CHIP 100PF	5.00% 50V
C043	1-163-037-11	CERAMIC CHIP 0.022UF	10.00% 50V	C536	1-117-667-11	FILM 0.47UF	5.00% 250V
				C537	1-106-351-00	MYLAR 0.0022UF	99% 200V

A

The components identified by shading and marked Δ are critical for safety. Replace only with the part number specified.

REF. NO.	PART.NO	DESCRIPTION	REMARK
C538	1-165-319-11	CERAMIC CHIP 0.1UF	50V
C539	1-107-642-91	ELECT 3.3UF	20.00% 200V
C540	1-136-206-11	MYLAR 0.033UF	10.00% 400V
C541	1-106-383-00	MYLAR 0.047UF	10.00% 200V
C542	1-162-131-11	CERAMIC 220PF	10.00% 2KV
C545	1-164-004-11	CERAMIC CHIP 0.1UF	10.00% 25V
C546	1-135-840-51	FILM 0.036UF	3% 400V
C547	1-117-671-21	FILM 1UF	5.00% 250V
C550	1-107-638-11	ELECT 33UF	20.00% 160V
C552	1-102-212-00	CERAMIC 820PF	10.00% 500V
C555	1-117-644-31	FILM 10000PF	3.00% 1.2KV
C580	1-163-021-91	CERAMIC CHIP 0.01UF	10.00% 50V
C582	1-163-255-11	CERAMIC CHIP 150PF	5.00% 50V
C583	1-163-009-11	CERAMIC CHIP 0.001UF	10.00% 50V
C600	1-119-888-51	CERAMIC 2200PF	20.00% 250V
C601	Δ 1-136-516-12	FILM 0.1UF	20.00% 300V
C602	Δ 1-136-516-12	FILM 0.1UF	20.00% 300V
C603	Δ 1-119-888-51	CERAMIC 2200PF	20.00% 250V
C604	Δ 1-119-888-51	CERAMIC 2200PF	20.00% 250V
C605	1-126-935-11	ELECT 470UF	20.00% 16V
C606	1-125-991-11	ELECT 180UF	20% 450V
C607	1-126-964-11	ELECT 10UF	20.00% 50V
C608	1-126-963-11	ELECT 4.7UF	20.00% 50V
C610	1-126-941-11	ELECT 470UF	20.00% 25V
C611	1-163-009-11	CERAMIC CHIP 0.001UF	10.00% 50V
C612	Δ 1-104-571-91	CERAMIC 0.0015UF	10.00% 2KV
C613	Δ 1-104-571-91	CERAMIC 0.0015UF	10.00% 2KV
C614	Δ 1-161-964-51	CERAMIC 0.0047UF	250V
C615	1-115-339-11	CERAMIC CHIP 0.1UF	10.00% 50V
C617	1-164-644-11	CERAMIC 330PF	10.00% 500V
C618	1-126-949-11	ELECT 220UF	20.00% 35V
C619	1-164-644-11	CERAMIC 330PF	10.00% 500V
C620	1-135-871-21	FILM 15000PF	3% 800V
C621	1-164-644-11	CERAMIC 330PF	10.00% 500V
C622	Δ 1-104-571-91	CERAMIC 0.0015UF	10.00% 2KV
C623	Δ 1-104-571-91	CERAMIC 0.0015UF	10.00% 2KV
C624	1-126-935-11	ELECT 470UF	20.00% 16V
C625	Δ 1-117-703-11	CERAMIC 0.0047UF	99% 250V
C626	1-126-967-11	ELECT 47UF	20.00% 50V
C627	1-126-964-11	ELECT 10UF	20.00% 50V
C628	1-126-963-11	ELECT 4.7UF	20.00% 50V
C630	1-107-640-41	ELECT 100UF	20.00% 160V
C631	1-126-942-61	ELECT 1000UF	20.00% 25V
C632	1-126-964-11	ELECT 10UF	20.00% 50V
C633	1-163-009-11	CERAMIC CHIP 0.001UF	10.00% 50V
C635	1-136-165-00	MYLAR 0.1UF	5.00% 50V
C636	1-136-479-11	FILM 0.001UF	2.00% 50V

REF. NO.	PART.NO	DESCRIPTION	REMARK
C637	1-126-967-11	ELECT 47UF	20.00% 50V
C638	1-107-679-91	ELECT 10UF	20.00% 450V
C639	1-104-665-11	ELECT 100UF	20.00% 25V
C640	1-104-664-11	ELECT 47UF	20.00% 25V
C641	1-111-036-11	ELECT 470UF	20.00% 16V
C642	1-104-665-11	ELECT 100UF	20.00% 25V
C643	1-164-644-11	CERAMIC 330PF	10.00% 500V
C645	1-164-004-11	CERAMIC CHIP 0.1UF	10.00% 25V
C648	1-125-782-91	CERAMIC 4700PF	10.00% 1KV
C657	1-126-952-11	ELECT 1000UF	20.00% 35V
C1201	1-126-952-11	ELECT 1000UF	20.00% 35V
C1205	1-163-033-91	CERAMIC CHIP 0.022UF	50V
C1207	1-115-340-11	CERAMIC CHIP 0.22UF	10.00% 25V
C1208	1-535-143-61	LEAD, JUMPER (5.0MM)	
C1218	1-109-982-11	CERAMIC CHIP 1UF	10.00% 10V
C1219	1-104-666-11	ELECT 220UF	20.00% 25V
C1220	1-164-346-11	CERAMIC CHIP 1UF	16V
C1221	1-115-339-11	CERAMIC CHIP 0.1UF	10.00% 50V
C1223	1-163-125-00	CERAMIC CHIP 220PF	5.00% 50V
C1226	1-110-501-11	CERAMIC CHIP 0.33UF	10.00% 16V
C1227	1-163-125-00	CERAMIC CHIP 220PF	5.00% 50V
< CONNECTOR >			
CN001	*1-564-508-11	PLUG, CONNECTOR 5P	
CN501	*1-580-798-11	CONNECTOR PIN (DY)	
CN504	*1-564-509-11	PLUG, CONNECTOR 6P	
CN506	1-695-915-11	TAB (CONTACT)	
CN508	*1-564-508-11	PLUG, CONNECTOR 5P	
CN510	*1-564-506-11	PLUG, CONNECTOR 3P	
CN601	Δ *1-580-843-11	PIN, CONNECTOR (POWER)	
CN602	Δ 1-508-765-00	PIN, CONNECTOR (5MM PITCH) 3P	
CN603	Δ *1-508-786-00	PIN, CONNECTOR (5MM PITCH) 2P	
CN604	Δ 1-695-915-11	TAB (CONTACT)	
< DIODE >			
D001	8-719-069-55	DIODE UDZS-TE17-5.6B	
D002	8-719-069-55	DIODE UDZS-TE17-5.6B	
D003	8-719-109-69	DIODE MTZJ-T-77-3.6B	
D004	8-719-302-45	DIODE SEL1210S-D	
D005	8-719-110-08	DIODE MTZJ-T-77-8.2B	
D006	8-719-109-89	DIODE MTZJ-T-77-5.6B	
D007	8-719-069-55	DIODE UDZS-TE17-5.6B	
D008	8-719-074-43	DIODE BAS316-115	
D010	8-719-074-43	DIODE BAS316-115	
D011	8-719-074-43	DIODE BAS316-115	
D012	8-719-110-08	DIODE MTZJ-T-77-8.2B	
D013	8-719-109-69	DIODE MTZJ-T-77-3.6B	

The components identified by shading and marked Δ are critical for safety
Replace only with the part number specified.

A

REF. NO.	PART.NO	DESCRIPTION	REMARK	REF. NO.	PART.NO	DESCRIPTION	REMARK
D014	8-719-422-12	DIODE UDZ-TE-17-3.9B		D601	8-719-510-53	DIODE D4SB60L-F	
D016	8-719-109-89	DIODE MTZJ-T-77-5.6B		D602	8-719-911-19	DIODE 1SS119-25TD	
D017	8-719-109-97	DIODE MTZJ-T-77-6.8B		D604	8-719-979-64	DIODE UF4005PKG23	
D018	8-719-109-69	DIODE MTZJ-T-77-3.6B		D608	8-719-063-70	DIODE D1NL20U-TA2	
D019	8-719-109-97	DIODE MTZJ-T-77-6.8B		D610	8-719-110-41	DIODE RD15ES-T1B2	
D020	8-719-109-89	DIODE MTZJ-T-77-5.6B		D611	8-719-991-33	DIODE 1SS133T-77	
D035	8-719-069-55	DIODE UDZS-TE17-5.6B		D612	8-719-991-33	DIODE 1SS133T-77	
D036	8-719-069-55	DIODE UDZS-TE17-5.6B		D613	8-719-911-19	DIODE 1SS119-25TD	
D051	8-719-978-33	DIODE UDZS-TE17-6.8B		D614	8-719-077-76	DIODE D2SB60A-F04	
D101	8-719-977-81	DIODE MA8330-TX		D615	8-719-110-08	DIODE MTZJ-T-77-8.2B	
D103	8-719-978-33	DIODE UDZS-TE17-6.8B		D616	8-719-052-90	DIODE D1NL40-TA2	
D104	8-719-069-55	DIODE UDZS-TE17-5.6B		D617	8-719-052-90	DIODE D1NL40-TA2	
D210	8-719-069-55	DIODE UDZS-TE17-5.6B		D618	8-719-022-97	DIODE D2S4MTA1	
D211	8-719-069-60	DIODE UDZS-TE17-9.1B		D619	8-719-022-97	DIODE D2S4MTA1	
D212	8-719-914-43	DIODE DAN202K-T-146		D620	8-719-109-85	DIODE MTZJ-T-77-5.1B	
D402	8-719-978-33	DIODE UDZS-TE17-6.8B		D621	8-719-109-89	DIODE MTZJ-T-77-5.6B	
D404	8-719-109-89	DIODE MTZJ-T-77-5.6B		D623	8-719-911-19	DIODE 1SS119-25TD	
D405	8-719-978-33	DIODE UDZS-TE17-6.8B		D627	8-719-063-70	DIODE D1NL20-TA	
D406	8-719-978-33	DIODE UDZS-TE17-6.8B		D629	8-719-073-23	DIODE ST02D-200TA	
D407	8-719-978-33	DIODE UDZS-TE17-6.8B		D631	8-719-921-63	DIODE MTZJ-T-77-7.5B	
D408	8-719-978-33	DIODE UDZS-TE17-6.8B		D632	8-719-063-70	DIODE D1NL20U-TA2	
D412	8-719-978-33	DIODE UDZS-TE17-6.8B		D633	8-719-109-69	DIODE MTZJ-T-77-3.6B	
D414	8-719-978-33	DIODE UDZS-TE17-6.8B		D634	8-719-074-43	DIODE BAS316-115	
D420	8-719-978-33	DIODE UDZS-TE17-6.8B		D639	8-719-080-59	DIODE EK19-V0	
D421	8-719-049-26	DIODE RB721QT-77		D640	8-719-921-63	DIODE MTZJ-T-77-7.5B	
D423	8-719-978-33	DIODE UDZS-TE17-6.8B		D1201	8-719-069-55	DIODE UDZS-TE17-5.6B	
D424	8-719-069-60	DIODE UDZS-TE17-9.1B		D1203	8-719-914-43	DIODE DAN202K-T-146	
D435	8-719-069-60	DIODE UDZS-TE17-9.1B		D1204	8-719-069-55	DIODE UDZS-TE17-5.6B	
D436	8-719-069-60	DIODE UDZS-TE17-9.1B				< FUSE >	
D501	8-719-908-03	DIODE GP08DPKG23		F601	Δ 1-576-232-21	FUSE (H.B.C.) 5A/250V	
D502	8-719-056-95	DIODE UDZ-TE-17-22B			Δ *1-533-725-11	HOLDER, FUSE (F601)	
D503	8-719-069-55	DIODE UDZS-TE17-5.6B				< FERRITE BEAD >	
D504	8-719-074-43	DIODE BAS316-115		FB601	1-410-397-21	FERRITE	1.1UH
D505	8-719-988-61	DIODE 1SS355TE-17		FB604	1-410-397-21	FERRITE	1.1UH
D506	8-719-908-03	DIODE GP08DPKG23		FB605	1-410-397-21	FERRITE	1.1UH
D507	8-719-070-59	DIODE PDZ6.8B-115		FB606	1-412-911-11	FERRITE	0UH
D512	8-719-908-03	DIODE GP08DPKG23		FB607	1-412-911-11	FERRITE	0UH
D513	8-719-908-03	DIODE GP08DPKG23				< IC >	
D514	8-719-908-03	DIODE GP08DPKG23		IC001	8-759-671-88	IC TDA9392H/N1/4/0131/T3	
D534	8-719-908-03	DIODE GP08DPKG23		IC002	8-749-017-44	IC TSOP1540SE1	
D535	8-719-908-03	DIODE GP08DPKG23		IC003	8-759-672-39	IC PST573IMT	
D536	8-719-945-80	DIODE ERC06-15SL		IC004	8-759-575-72	IC M24C08-WMNGT	
D537	8-719-110-14	DIODE MTZJ-T-77-9.1C		IC401	8-759-665-11	IC LM393DT	
D538	8-719-908-03	DIODE GP08DPKG23					
D539	8-719-928-08	DIODE ERD28-06S		IC501	8-759-339-59	IC TDA8177	
D541	1-535-143-61	LEAD, JUMPER (5.0MM)					
D573	8-719-976-96	DIODE UDZ-TE-17-4.7B					

A

The components identified by shading and marked Δ are critical for safety
 Replace only with the part number specified.

REF. NO.	PART.NO	DESCRIPTION	REMARK	REF. NO.	PART.NO	DESCRIPTION	REMARK
IC531	8-759-665-11	IC LM393DT		Q401	8-729-026-49	TRANSISTOR 2SA1037AK-T146-QR	
IC601	8-759-671-30	IC MCZ3001D		Q411	8-729-120-28	TRANSISTOR 2SC2412K-T-146-R	
IC602	8-749-016-19	IC SE135N-LF4		Q532	8-729-053-33	TRANSISTOR IRF614-037	
IC604	8-759-668-87	IC BA41W12ST-V5		Q533	8-729-051-82	TRANSISTOR BU4508DX-ON5210	
IC608	8-759-591-02	IC L78L33ABZ-AP		Q535	8-729-053-33	TRANSISTOR IRF614-037	
IC609	8-759-468-89	IC TOP209P		Q601	8-729-026-49	TRANSISTOR 2SA1037AK-T146-QR	
IC1201	8-759-665-29	IC TDA7494S		Q602	8-729-119-78	TRANSISTOR 2SC1740S-RT	
	< SOCKET >			Q603	8-729-029-56	TRANSISTOR DTA144ESA-TP	
J401	1-770-130-11	CONNECTOR (SQUARE TYPE) 21P		Q604	8-729-030-02	TRANSISTOR DTC144ESA-TP	
J402	1-794-344-11	JACK, PIN 2P		Q606	8-729-052-29	TRANSISTOR 2SK2876-01MR-F122	
J1200	1-568-267-21	JACK		Q607	8-729-052-29	TRANSISTOR 2SK2876-01MR-F122	
	< COIL >			Q608	8-729-120-28	TRANSISTOR 2SC2412K-T-146-QR	
L001	1-408-611-31	INDUCTOR	47UH	Q609	8-729-026-49	TRANSISTOR 2SA1037AK-T146-QR	
L002	1-410-119-11	INDUCTOR	1MH		< RESISTOR >		
L004	1-408-611-31	INDUCTOR	47UH	JR002	1-216-295-91	SHORT	0
L006	1-408-611-31	INDUCTOR	47UH	JR009	1-216-295-91	SHORT	0
L027	1-216-295-91	SHORT	0	JR023	1-216-295-91	SHORT	0
L101	1-412-533-21	INDUCTOR	47UH	JR208	1-216-295-91	SHORT	0
L102	1-408-611-31	INDUCTOR	47UH	JR403	1-216-295-91	SHORT	0
L405	1-535-143-61	LEAD, JUMPER	(5.0MM)	JR404	1-216-295-91	SHORT	0
L407	1-535-143-61	LEAD, JUMPER	(5.0MM)	JR406	1-216-295-91	SHORT	0
L410	1-216-025-91	RES-CHIP	100 5% 1/10W	JR408	1-216-296-91	SHORT	0
L446	1-216-295-91	SHORT	0	JR409	1-216-295-91	SHORT	0
L501	1-414-187-11	INDUCTOR	47UH	JR420	1-216-295-91	SHORT	0
L502	1-412-531-31	INDUCTOR	33UH	JR508	1-216-295-91	SHORT	0
L503	1-412-521-31	INDUCTOR	4.7UH	JR516	1-216-296-91	SHORT	0
L504	1-535-143-61	LEAD, JUMPER	(5.0MM)	JR517	1-216-296-91	SHORT	0
L505	1-412-533-21	INDUCTOR	47UH	JR601	1-216-296-91	SHORT	0
L507	1-412-533-21	INDUCTOR	47UH	R003	1-216-065-91	RES-CHIP	4.7K 5% 1/10W
L532	1-412-553-11	INDUCTOR	3.3MH	R004	1-216-033-00	RES-CHIP	220 5% 1/10W
L533	1-406-989-21	INDUCTOR	10MH	R005	1-216-190-00	RES-CHIP	470 5% 1/8W
L535	1-459-111-00	INDUCTOR	10MH	R006	1-216-025-91	RES-CHIP	100 5% 1/10W
L537	1-419-552-11	COIL, HORIZONTAL LINEARITY		R007	1-216-025-91	RES-CHIP	100 5% 1/10W
L538	1-419-263-11	COIL, WITH CORE		R008	1-216-025-91	RES-CHIP	100 5% 1/10W
L601	1-408-603-31	INDUCTOR	10UH	R009	1-216-049-91	RES-CHIP	1K 5% 1/10W
L602	1-408-611-31	INDUCTOR	47UH	R010	1-216-059-00	RES-CHIP	2.7K 5% 1/10W
L1203	1-535-143-61	LEAD, JUMPER	(5.0MM)	R011	1-216-295-91	SHORT	0
	< PHOTO COUPLER >			R012	1-216-113-00	RES-CHIP	470K 5% 1/10W
PH601 Δ	8-749-016-21	IC TCET1103G		R014	1-216-065-91	RES-CHIP	4.7K 5% 1/10W
	< TRANSISTOR >			R017	1-216-174-00	RES-CHIP	100 5% 1/8W
Q013	8-729-120-28	TRANSISTOR 2SC2412K-T-146-R		R018	1-216-689-11	METAL CHIP	39K 0.5% 1/10W
Q016	8-729-120-28	TRANSISTOR 2SC2412K-T-146-R		R020	1-216-077-91	RES-CHIP	15K 5% 1/10W
Q212	8-729-422-33	TRANSISTOR 2PD601AR-115		R021	1-216-065-91	RES-CHIP	4.7K 5% 1/10W
				R022	1-216-089-91	RES-CHIP	47K 5% 1/10W
				R023	1-216-180-00	RES-CHIP	180 5% 1/8W
				R024	1-216-025-91	RES-CHIP	100 5% 1/10W

REF. NO.	PART.NO	DESCRIPTION	REMARK	REF. NO.	PART.NO	DESCRIPTION	REMARK
R025	1-216-025-91	RES-CHIP	100 5% 1/10W	R096	1-216-025-91	RES-CHIP	100 5% 1/10W
R026	1-216-025-91	RES-CHIP	100 5% 1/10W	R101	1-216-093-91	RES-CHIP	68K 5% 1/10W
R027	1-216-025-91	RES-CHIP	100 5% 1/10W	R102	1-216-097-91	RES-CHIP	100K 5% 1/10W
R028	1-216-025-91	RES-CHIP	100 5% 1/10W	R104	1-216-295-91	SHORT	0
R029	1-216-061-00	RES-CHIP	3.3K 5% 1/10W	R106	1-215-900-11	METAL OXIDE	22K 5% 2W
R031	1-216-210-00	RES-CHIP	3.3K 5% 1/8W	R107	1-216-025-91	RES-CHIP	100 5% 1/10W
R032	1-216-061-00	RES-CHIP	3.3K 5% 1/10W	R108	1-216-025-91	RES-CHIP	100 5% 1/10W
R033	1-216-073-00	RES-CHIP	10K 5% 1/10W	R246	1-260-107-11	CARBON	4.7K 5% 1/2W
R034	1-216-121-91	RES-CHIP	1M 5% 1/10W	R248	1-249-429-11	CARBON	10K 5% 1/4W
R035	1-216-101-00	RES-CHIP	150K 5% 1/10W	R249	1-216-097-91	RES-CHIP	100K 5% 1/10W
R036	1-216-083-00	RES-CHIP	27K 5% 1/10W	R250	1-216-230-00	RES-CHIP	22K 5% 1/8W
R038	1-216-295-91	SHORT	0	R401	1-216-214-00	RES-CHIP	4.7K 5% 1/8W
R039	1-216-214-00	RES-CHIP	4.7K 5% 1/8W	R404	1-216-113-00	RES-CHIP	470K 5% 1/10W
R040	1-216-049-91	RES-CHIP	1K 5% 1/10W	R406	1-216-214-00	RES-CHIP	4.7K 5% 1/8W
R041	1-216-025-91	RES-CHIP	100 5% 1/10W	R408	1-216-022-00	RES-CHIP	75 5% 1/10W
R042	1-216-025-91	RES-CHIP	100 5% 1/10W	R409	1-216-025-91	RES-CHIP	100 5% 1/10W
R044	1-216-073-00	RES-CHIP	10K 5% 1/10W	R410	1-216-025-91	RES-CHIP	100 5% 1/10W
R045	1-216-025-91	RES-CHIP	100 5% 1/10W	R411	1-216-022-00	RES-CHIP	75 5% 1/10W
R046	1-216-025-91	RES-CHIP	100 5% 1/10W	R412	1-216-025-91	RES-CHIP	100 5% 1/10W
R047	1-216-025-91	RES-CHIP	100 5% 1/10W	R414	1-216-022-00	RES-CHIP	75 5% 1/10W
R048	1-216-073-00	RES-CHIP	10K 5% 1/10W	R415	1-216-022-00	RES-CHIP	75 5% 1/10W
R050	1-216-174-00	RES-CHIP	100 5% 1/8W	R416	1-216-027-00	RES-CHIP	120 5% 1/10W
R051	1-216-295-91	SHORT	0	R419	1-216-022-00	RES-CHIP	75 5% 1/10W
R055	1-216-174-00	RES-CHIP	100 5% 1/8W	R420	1-216-073-00	RES-CHIP	10K 5% 1/10W
R056	1-216-081-00	RES-CHIP	22K 5% 1/10W	R421	1-216-049-91	RES-CHIP	1K 5% 1/10W
R057	1-216-083-00	RES-CHIP	27K 5% 1/10W	R423	1-216-113-00	RES-CHIP	470K 5% 1/10W
R060	1-216-174-00	RES-CHIP	100 5% 1/8W	R425	1-216-085-00	RES-CHIP	33K 5% 1/10W
R061	1-216-174-00	RES-CHIP	100 5% 1/8W	R426	1-216-073-00	RES-CHIP	10K 5% 1/10W
R062	1-216-077-91	RES-CHIP	15K 5% 1/10W	R428	1-216-073-00	RES-CHIP	10K 5% 1/10W
R063	1-216-061-00	RES-CHIP	3.3K 5% 1/10W	R429	1-216-089-91	RES-CHIP	47K 5% 1/10W
R064	1-216-069-00	RES-CHIP	6.8K 5% 1/10W	R430	1-216-073-00	RES-CHIP	10K 5% 1/10W
R065	1-216-295-91	SHORT	0	R431	1-216-073-00	RES-CHIP	10K 5% 1/10W
R066	1-216-053-00	RES-CHIP	1.5K 5% 1/10W	R433	1-216-073-00	RES-CHIP	10K 5% 1/10W
R067	1-216-073-00	RES-CHIP	10K 5% 1/10W	R434	1-216-073-00	RES-CHIP	10K 5% 1/10W
R068	1-216-083-00	RES-CHIP	27K 5% 1/10W	R435	1-216-295-91	SHORT	0
R069	1-216-073-00	RES-CHIP	10K 5% 1/10W	R440	1-216-049-91	RES-CHIP	1K 5% 1/10W
R070	1-216-025-91	RES-CHIP	100 5% 1/10W	R441	1-216-051-00	RES-CHIP	1.2K 5% 1/10W
R071	1-216-049-91	RES-CHIP	1K 5% 1/10W	R444	1-216-061-00	RES-CHIP	3.3K 5% 1/10W
R072	1-216-295-91	SHORT	0	R445	1-216-022-00	RES-CHIP	75 5% 1/10W
R074	1-216-073-00	RES-CHIP	10K 5% 1/10W	R446	1-216-113-00	RES-CHIP	470K 5% 1/10W
R075	1-216-295-91	SHORT	0	R447	1-216-295-91	SHORT	0
R089	1-216-081-00	RES-CHIP	22K 5% 1/10W	R453	1-216-171-00	RES-CHIP	75 5% 1/8W
R090	1-216-057-00	RES-CHIP	2.2K 5% 1/10W	R454	1-216-001-00	RES-CHIP	10 5% 1/10W
R092	1-216-073-00	RES-CHIP	10K 5% 1/10W	R461	1-216-022-00	RES-CHIP	75 5% 1/10W
R093	1-216-081-00	RES-CHIP	22K 5% 1/10W	R501	1-216-091-00	RES-CHIP	56K 5% 1/10W
R094	1-216-025-91	RES-CHIP	100 5% 1/10W	R502	1-216-073-00	RES-CHIP	10K 5% 1/10W
R095	1-216-065-91	RES-CHIP	4.7K 5% 1/10W	R503	1-215-888-00	METAL OXIDE	220 5% 2W

A

The components identified by shading and marked Δ are critical for safety
 Replace only with the part number specified.

REF. NO.	PART.NO	DESCRIPTION	REMARK	REF. NO.	PART.NO	DESCRIPTION	REMARK
R504	1-249-385-11	CARBON	2.2 5% 1/4W	R562	1-216-117-00	RES-CHIP	680K 5% 1/10W
R505	1-216-677-11	METAL CHIP	12K 0.5% 1/10W	R565	1-216-049-91	RES-CHIP	1K 5% 1/10W
R506	1-216-665-11	METAL CHIP	3.9K 0.5% 1/10W	R583	1-216-081-00	RES-CHIP	22K 5% 1/10W
R507	1-216-349-00	METAL OXIDE	1 5% 1W	R589	1-216-295-91	SHORT	0
R508	1-216-677-11	METAL CHIP	12K 0.5% 1/10W	R590	1-216-222-00	RES-CHIP	10K 5% 1/8W
R509	1-216-665-11	METAL CHIP	3.9K 0.5% 1/10W	R591	1-215-892-11	METAL OXIDE	1K 5% 2W
R510	1-216-113-00	RES-CHIP	470K 5% 1/10W	R595	1-249-377-11	CARBON	0.47 5% 1/4W
R512	1-249-382-11	CARBON	1.2 5% 1/4W	R600	1-216-615-91	METAL CHIP	33 0.5% 1/10W
R514	1-249-377-11	CARBON	0.47 5% 1/4W	R601	1-216-645-11	METAL CHIP	560 0.5% 1/10W
R515	1-249-377-11	CARBON	0.47 5% 1/4W	R602	1-202-962-11	CEMENTED	3.3 5% 10W
R516	1-214-907-00	METAL	56K 1% 1/2W	R603	1-220-926-11	FUSIBLE	0.47 10% 1/2W
R517	1-215-463-00	METAL	56K 1% 1/4W	R605	1-216-049-91	RES-CHIP	1K 5% 1/10W
R518	1-216-059-00	RES-CHIP	2.7K 5% 1/10W	R606	Δ 1-202-719-00	SOLID	1M 10% 1/2W
R519	1-216-129-00	RES-CHIP	2.2M 5% 1/10W	R608	1-216-073-00	RES-CHIP	10K 5% 1/10W
R520	1-215-883-11	METAL OXIDE	33 5% 2W	R609	1-216-675-91	METAL CHIP	10K 0.5% 1/10W
R523	1-216-117-00	RES-CHIP	680K 5% 1/10W	R610	1-215-481-00	METAL	330K 1% 1/4W
R524	1-216-083-00	RES-CHIP	27K 5% 1/10W	R611	1-216-059-00	RES-CHIP	2.7K 5% 1/10W
R525	1-216-057-00	RES-CHIP	2.2K 5% 1/10W	R612	1-249-429-11	CARBON	10K 5% 1/4W
R526	1-216-089-91	RES-CHIP	47K 5% 1/10W	R613	Δ 1-218-265-11	METAL	8.2M 5% 1W
R527	1-216-079-00	RES-CHIP	18K 5% 1/10W	R615	1-215-405-00	METAL	220 1% 1/4W
R528	1-216-097-91	RES-CHIP	100K 5% 1/10W	R618	1-247-889-00	CARBON	270K 5% 1/4W
R529	1-216-073-00	RES-CHIP	10K 5% 1/10W	R619	1-216-065-91	RES-CHIP	4.7K 5% 1/10W
R530	1-216-085-00	RES-CHIP	33K 5% 1/10W	R621	1-216-113-00	RES-CHIP	470K 5% 1/10W
R531	1-216-057-00	RES-CHIP	2.2K 5% 1/10W	R622	1-216-073-00	RES-CHIP	10K 5% 1/10W
R532	1-216-085-00	RES-CHIP	33K 5% 1/10W	R623	1-216-081-00	RES-CHIP	22K 5% 1/10W
R533	1-216-081-00	RES-CHIP	22K 5% 1/10W	R624	1-216-001-00	RES-CHIP	10 5% 1/10W
R534	1-216-117-00	RES-CHIP	680K 5% 1/10W	R625	1-216-073-00	RES-CHIP	10K 5% 1/10W
R535	1-216-097-91	RES-CHIP	100K 5% 1/10W	R627	1-249-389-11	CARBON	4.7 5% 1/4W
R539	1-215-892-11	METAL OXIDE	1K 5% 2W	R628	1-247-791-91	CARBON	22 5% 1/4W
R540	1-215-887-00	METAL OXIDE	150 5% 2W	R629	1-216-073-00	RES-CHIP	10K 5% 1/10W
R542	1-216-121-91	RES-CHIP	1M 5% 1/10W	R632	1-249-417-11	CARBON	1K 5% 1/4W
R543	1-216-065-91	RES-CHIP	4.7K 5% 1/10W	R633	1-215-481-00	METAL	330K 1% 1/4W
R544	1-216-103-00	RES-CHIP	180K 5% 1/10W	R634	1-216-361-21	METAL OXIDE	0.22 5% 2W
R545	1-216-129-00	RES-CHIP	2.2M 5% 1/10W	R635	1-260-300-11	CARBON	4.7 5% 1/2W
R546	1-215-894-11	METAL OXIDE	2.2K 5% 2W	R636	1-249-413-11	CARBON	470 5% 1/4W
R547	1-215-886-11	METAL OXIDE	100 5% 2W	R637	1-216-041-00	RES-CHIP	470 5% 1/10W
R548	1-212-849-00	FUSIBLE	4.7 5% 1/4W	R639	1-216-683-11	METAL CHIP	22K 0.5% 1/10W
R549	1-216-369-00	METAL OXIDE	1 5% 2W	R640	1-216-699-91	METAL CHIP	100K 0.5% 1/10W
R551	1-215-873-00	METAL OXIDE	4.7K 5% 1W	R641	1-216-097-91	RES-CHIP	100K 5% 1/10W
R552	1-216-097-91	RES-CHIP	100K 5% 1/10W	R642	1-249-405-11	CARBON	100 5% 1/4W
R553	1-249-381-11	CARBON	1 5% 1/4W	R643	1-216-089-91	RES-CHIP	47K 5% 1/10W
R554	1-216-254-00	RES-CHIP	220K 5% 1/8W	R645	1-216-073-00	RES-CHIP	10K 5% 1/10W
R557	1-216-065-91	RES-CHIP	4.7K 5% 1/10W	R647	1-216-049-91	RES-CHIP	1K 5% 1/10W
R558	1-216-025-91	RES-CHIP	100 5% 1/10W	R648	1-215-481-00	METAL	330K 1% 1/4W
R559	1-249-428-11	CARBON	8.2K 5% 1/4W	R649	1-216-674-11	METAL CHIP	9.1K 0.5% 1/10W
R560	1-249-429-11	CARBON	10K 5% 1/4W	R650	1-216-627-11	METAL CHIP	100 0.5% 1/10W
R561	1-216-129-00	RES-CHIP	2.2M 5% 1/10W	R651	1-220-926-11	FUSIBLE	0.47 10% 1/2W

The components identified by shading and marked Δ are critical for safety
Replace only with the part number specified.

C **A**

REF. NO.	PART. NO	DESCRIPTION	REMARK	REF. NO.	PART. NO	DESCRIPTION	REMARK
R652	1-216-081-00	RES-CHIP	22K 5% 1/10W	A Board Variant Parts KV-21LT1B/21LT1E KV-21LT1K/21LT1U			
R653	1-216-073-00	RES-CHIP	10K 5% 1/10W				
R654	1-216-001-00	RES-CHIP	10 5% 1/10W				
R656	1-216-365-00	METAL OXIDE	0.47 5% 2W				
R660	1-247-807-31	CARBON	100 5% 1/4W				
R1200	1-260-093-11	CARBON	330 5% 1/2W				
R1201	1-260-093-11	CARBON	330 5% 1/2W				
R1204	1-216-049-91	RES-CHIP	1K 5% 1/10W				
R1205	1-216-061-00	RES-CHIP	3.3K 5% 1/10W				
R1206	1-216-073-00	RES-CHIP	10K 5% 1/10W				
R1207	1-216-083-00	RES-CHIP	27K 5% 1/10W	A Board Variant Parts KV-21FT2K			
R1213	1-216-198-91	RES-CHIP	1K 5% 1/8W				
< RELAY >							
RY601	Δ 1-755-388-11	RELAY (AC POWER)					
< SWITCH >							
S001	1-571-532-21	SWITCH, TACTIL					
S002	1-571-532-21	SWITCH, TACTIL					
S003	1-571-532-21	SWITCH, TACTIL					
S004	1-571-532-21	SWITCH, TACTIL					
S005	1-571-532-21	SWITCH, TACTIL					
S006	1-571-532-21	SWITCH, TACTIL		*A-1639-004-A C Board, Complete			
S601	Δ 1-571-433-21	SWITCH, PUSH (AC POWER)					
SW532	1-572-707-11	SWITCH, LEVER					
< TRANSFORMER >							
T511	Δ 1-453-345-11	TRANSFORMER ASSY, FLYBACK (NX1748//M3A4)					
T531	1-437-210-11	TRANSFORMER, HORIZONTAL DRIVE					
T601	Δ 1-435-487-11	TRANSFORMER, LINE FILTER					
T602	1-431-732-31	TRANSFORMER, CONVERTER (SRT)					
T603	Δ 1-435-525-11	TRANSFORMER, CONVERTER (PIT)					
< THERMISTOR >							
TH601	1-803-586-11	THERMISTOR, NTC					
THP601	Δ 1-803-951-11	THERMISTOR, PTC					
< VARISTOR >							
VDR601	Δ 1-803-830-11	VARISTOR (ERZV14D621)					
< CRYSTAL >							
X001	1-578-774-11	VIBRATOR, CRYSTAL					
C1203	1-126-942-61	ELECT	1000UF 20.00% 25V	A Board Variant Parts KV-21FT2K			
< CAPACITOR >							
CN1201	1-504-506-11	PLUG, CONNECTOR 3P					
< COIL >							
L603	1-412-519-11	INDUCTOR	3.3UH				
L1200	1-535-143-61	LEAD, JUMPER	(5.0MM)				
< TUNER >							
TU101	8-598-535-00	FRONTEND BTF-EF411	(KV-21LT1B)				
	8-598-531-00	FRONTEND BTF-EC401	(KV-21LT1E)				
	8-598-537-00	FRONTEND BTF-EP401	(KV-21LT1K)				
	8-598-527-00	FRONTEND BTF-EU601	(KV-21LT1U)				
< CAPACITOR >							
C1203	1-535-143-61	LEAD, JUMPER	(5.0MM)	*A-1639-004-A C Board, Complete			
C1208	1-126-953-11	ELECT	2200UF 20.00% 35V				
< CONNECTOR >							
CN1201	1-504-507-11	PLUG, CONNECTOR 4P					
< COIL >							
L603	1-535-143-61	LEAD, JUMPER	(5.0MM)				
< TUNER >							
TU101	8-598-537-00	FRONTEND BTF-EP401					
< CAPACITOR >							
C701	1-126-934-11	ELECT	220UF 20.00% 16V				
C702	1-102-110-00	CERAMIC	220PF 10.00% 50V				
C703	1-102-110-00	CERAMIC	220PF 10.00% 50V				
C704	1-101-004-00	CERAMIC	0.01UF 50V				
C705	1-101-004-00	CERAMIC	0.01UF 50V				
C708	1-162-114-00	CERAMIC	0.0047UF 2KV				
C710	1-107-957-11	ELECT	1UF 20.00% 250V				
C712	1-102-110-00	CERAMIC	220PF 10.00% 50V				



The components identified by shading and marked Δ are critical for safety. Replace only with the part number specified.

REF. NO.	PART.NO	DESCRIPTION	REMARK
C713	1-101-004-00	CERAMIC 0.01UF	50V
C714	1-104-665-11	ELECT 100UF	20.00% 16V
C717	1-102-114-00	CERAMIC 470PF	10.00% 50V
C718	1-102-114-00	CERAMIC 470PF	10.00% 50V
C719	1-102-114-00	CERAMIC 470PF	10.00% 50V
C1803	1-101-005-00	CERAMIC 0.022UF	50V
C1804	1-126-964-11	ELECT 10UF	20.00% 50V
C1805	1-137-366-11	MYLAR 0.0022UF	5.00% 50V
< CONNECTOR >			
CN702	1-695-915-11	TAB (CONTACT)	
CN703	*1-564-509-11	PLUG, CONNECTOR 6P	
CN706	1-695-915-11	TAB (CONTACT)	
CN707	*1-564-508-11	PLUG, CONNECTOR 5P	
CN1705	*1-564-506-11	PLUG, CONNECTOR 3P	
CN1801	*1-564-506-11	PLUG, CONNECTOR 3P	
< DIODE >			
D701	8-719-109-93	DIODE MTZJ-T-77-6.2B	
D702	8-719-991-33	DIODE 1SS133T-77	
D703	1-535-143-61	LEAD, JUMPER (5.0MM)	
D704	1-535-143-61	LEAD, JUMPER (5.0MM)	
D705	1-535-143-61	LEAD, JUMPER (5.0MM)	
D706	8-719-991-33	DIODE 1SS133T-77	
D707	8-719-991-33	DIODE 1SS133T-77	
D708	8-719-991-33	DIODE 1SS133T-77	
D709	8-719-991-33	DIODE 1SS133T-77	
D710	8-719-991-33	DIODE 1SS133T-77	
D712	8-719-991-33	DIODE 1SS133T-77	
D713	8-719-950-57	DIODE BYD33G-AMMO	
D714	8-719-991-33	DIODE 1SS133T-77	
D715	8-719-991-33	DIODE 1SS133T-77	
D716	8-719-991-33	DIODE 1SS133T-77	
D717	8-719-991-33	DIODE 1SS133T-77	
D718	8-719-991-33	DIODE 1SS133T-77	
D719	8-719-991-33	DIODE 1SS133T-77	
D720	8-719-110-41	DIODE MTZJ-T-77-15B	
D721	8-719-991-33	DIODE 1SS133T-77	
D722	8-719-991-33	DIODE 1SS133T-77	
D723	8-719-991-33	DIODE 1SS133T-77	
D724	8-719-991-33	DIODE 1SS133T-77	
D725	8-719-991-33	DIODE 1SS133T-77	
D726	8-719-991-33	DIODE 1SS133T-77	
D1801	8-719-110-17	DIODE MTZJ-T-77-10	
D1802	8-719-110-17	DIODE MTZJ-T-77-10	
D1803	8-719-110-17	DIODE MTZJ-T-77-10	

REF. NO.	PART.NO	DESCRIPTION	REMARK
< IC >			
IC1801	8-759-603-37	IC M5216P	
< SOCKET >			
J701	Δ 1-251-595-11	SOCKET, CRT	
< COIL >			
L704	1-414-183-41	INDUCTOR 10UH	
< TRANSISTOR >			
Q701	8-729-046-28	TRANSISTOR BF420-126	
Q702	8-729-119-78	TRANSISTOR 2SC1740S-RT	
Q703	8-729-046-28	TRANSISTOR BF420-126	
Q704	8-729-200-17	TRANSISTOR BF421-AMMO	
Q705	8-729-119-78	TRANSISTOR 2SC1740S-RT	
Q706	8-729-046-28	TRANSISTOR BF420-126	
Q707	8-729-200-17	TRANSISTOR BF421-AMMO	
Q708	8-729-119-78	TRANSISTOR 2SC1740S-RT	
Q709	8-729-046-28	TRANSISTOR BF420-126	
Q710	8-729-200-17	TRANSISTOR BF421-AMMO	
Q712	8-729-046-28	TRANSISTOR BF420-126	
Q713	8-729-046-28	TRANSISTOR BF420-126	
Q715	8-729-200-17	TRANSISTOR BF421-AMMO	
Q716	8-729-200-17	TRANSISTOR BF421-AMMO	
Q717	8-729-200-17	TRANSISTOR BF421-AMMO	
Q718	8-729-119-78	TRANSISTOR 2SC1740S-RT	
< RESISTOR >			
R701	1-247-895-91	CARBON 470K 5% 1/4W	
R702	1-215-900-11	METAL OXIDE 22K 5% 2W	
R703	1-249-405-11	CARBON 100 5% 1/4W	
R704	1-249-401-11	CARBON 47 5% 1/4W	
R705	1-215-871-11	METAL OXIDE 2.2K 5% 1W	
R706	1-249-409-11	CARBON 220 5% 1/4W	
R707	1-249-414-11	CARBON 560 5% 1/4W	
R708	1-247-807-31	CARBON 100 5% 1/4W	
R709	1-249-429-11	CARBON 10K 5% 1/4W	
R711	1-249-421-11	CARBON 2.2K 5% 1/4W	
R712	1-215-871-11	METAL OXIDE 2.2K 5% 1W	
R714	1-215-900-11	METAL OXIDE 22K 5% 2W	
R715	1-249-405-11	CARBON 100 5% 1/4W	
R716	1-249-409-11	CARBON 220 5% 1/4W	
R717	1-249-414-11	CARBON 560 5% 1/4W	
R718	1-202-814-11	SOLID 33K 10% 1/2W	
R719	1-247-807-31	CARBON 100 5% 1/4W	

The components identified by shading and marked Δ are critical for safety
 Replace only with the part number specified.

C

REF. NO.	PART.NO	DESCRIPTION	REMARK	REF. NO.	PART.NO	DESCRIPTION	REMARK
R720	1-249-421-11	CARBON	2.2K 5% 1/4W				
R721	1-249-405-11	CARBON	100 5% 1/4W				
R722	1-249-393-11	CARBON	10 5% 1/4W				
R723	1-249-393-11	CARBON	10 5% 1/4W				
R724	1-249-393-11	CARBON	10 5% 1/4W				
R726	1-215-871-11	METAL OXIDE	2.2K 5% 1W				
R727	1-249-409-11	CARBON	220 5% 1/4W				
R728	1-216-372-11	METAL OXIDE	1.8 5% 2W				
R729	1-249-414-11	CARBON	560 5% 1/4W				
R730	1-247-807-31	CARBON	100 5% 1/4W				
R731	1-249-421-11	CARBON	2.2K 5% 1/4W				
R734	1-247-807-31	CARBON	100 5% 1/4W				
R736	1-215-900-11	METAL OXIDE	22K 5% 2W				
R741	1-202-549-00	SOLID	100 20% 1/2W				
R1801	1-249-441-11	CARBON	100K 5% 1/4W				
R1805	1-249-429-11	CARBON	10K 5% 1/4W				
R1806	1-247-899-11	CARBON	680K 5% 1/4W				
R1807	1-249-429-11	CARBON	10K 5% 1/4W				
R1808	1-249-429-11	CARBON	10K 5% 1/4W				
R1809	1-249-429-11	CARBON	10K 5% 1/4W				
R1810	1-249-429-11	CARBON	10K 5% 1/4W				
		< VARIABLE RESISTOR >					
RV702	1-241-656-21	RES, ADJ, METAL FILM 110M					
REMOTE COMMANDER							
	1-418-476-21	REMOTE COMMANDER (RM-887)					
MISCELLANEOUS							
	Δ 1-419-187-11	COIL DEGAUSSING					
	1-452-032-00	MAGNET, DISK; 10MM					
	1-452-094-00	MAGNET, ROTATABLE DISK; 15MM					
	Δ 1-453-345-11	TRANSFORMER ASSY, FLYBACK (NX-1748//M3A4)					
	1-452-728-61	COIL, NA ROTATION (RT-154)					
	1-529-711-11	SPEAKER (8CM) (KV-21LT1)					
	1-529-710-11	SPEAKER (5x9CM) (KV-21FT2)					
	Δ 1-571-433-21	SWITCH, PUSH (AC POWER)					
	Δ 1-765-286-11	CORD, POWER (KV-21LT1B/21LT1E/21LT1K/21FT2K)					
	Δ 1-776-860-11	POWER CORD, FILTER (KV-21LT1U)					
	Δ 8-738-836-05	PICTURE TUBE (A51LPT60X) (SD-313)					
	Δ 8-451-505-11	DEFLECTION YOKE (Y21RSA-S)					
	Δ 1-251-839-21	CAP ASSY, HIGH VOLTAGE					
	8-598-535-00	FRONTEND BTF-EF411 (KV-21LT1B)					
	8-598-531-00	FRONTEND BTF-EC401 (KV-21LT1E)					
	8-598-537-00	FRONTEND BTF-EP401 (KV-21LT1K/KV-21FT2K)					
	8-598-527-00	FRONTEND BTF-EU601 (KV-21LT1U)					
ACCESSORIES AND PACKAGING MATERIALS							
	*4-205-481-21	MANUAL, INSTRUCTION (KV-21LT1B) (GERMAN/FRENCH/ITALIAN/DUTCH)					
	*4-205-481-71	MANUAL, INSTRUCTION (KV-21LT1B) (ENGLISH)					
	*4-205-481-11	MANUAL, INSTRUCTION (KV-21LT1E) (GERMAN/GREEK/TURKISH)					
	*4-205-481-51	MANUAL, INSTRUCTION (KV-21LT1E) (SPANISH/PORTUGUESE/FINNISH/SWEDISH/ DANISH/NORWEGIAN)					
	*4-205-481-61	MANUAL, INSTRUCTION (KV-21LT1E) (ITALIAN)					
	*4-205-481-41	MANUAL, INSTRUCTION (KV-21LT1K) (BELGIAN/CZECH/ENGLISH/DUTCH/ POLISH/RUSSIAN/SLOVAKIAN)					
	*4-205-481-31	MANUAL, INSTRUCTION (KV-21LT1U) (ENGLISH)					
	*4-205-400-41	MANUAL, INSTRUCTION (KV-21FT2K) (BELGIAN/CZECH/ENGLISH/DUTCH/ POLISH/RUSSIAN/SLOVAKIAN)					
	*4-395-957-01	BAG, PROTECTION					
	*4-205-642-01	INDIVIDUAL CARTON (KV-21LT1)					
	*4-205-407-01	INDIVIDUAL CARTON (KV-21FT2)					
	*4-205-675-01	CUSHION (UPPER) (ASSY) (KV-21LT1)					
	*4-205-404-01	CUSHION (UPPER) (ASSY) (KV-21FT2)					
	*4-205-674-01	CUSHION (LOWER) (ASSY) (KV-21LT1)					
	*4-205-401-01	CUSHION (LOWER) (ASSY) (KV-21FT2)					

TRACE

A new TV Repair Assistance Tool that combines ease of use and powerful PC software tools to allow you to save valuable time during many TV repairs.



The TRACE interface connects to the PC's serial port. It provides connection to the TV's I²C bus and can be provided with an InfraRed transmitter (optional).

The interface is powered by a standard 9 V PP3 battery for portable use, and can also be powered by an external 9V/25mA DC power supply.

The TRACE software that is supplied with the interface allows you to:

- Read, restore and compare NVM contents via the I²C bus
- Acknowledge check of all I²C devices in the TV set
- Read Error Codes (emulation of the Error Reader tool)

With the optional IR Add-on kit, the following features can be added:

- Remote Commander emulation
- User programmable Functional Check through Infrared
- Fast and documented Test Mode setting of all Sony TV chassis

Additional features such as Adjustments and Troubleshooting are available in chassis-dependent software modules. Please contact your local Sony Service organisation for the latest information.

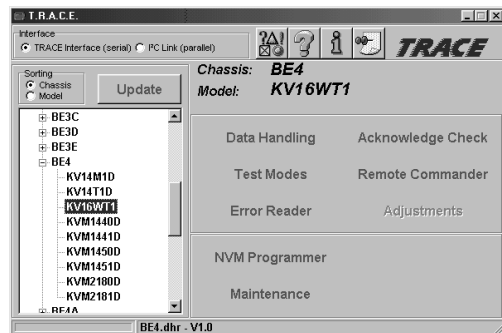

Note: For workshops already using the existing I²C Link parallel port interface (9-948-320-30), this software can be used as well, replacing the TV Data Handling software (9-948-340-50), but Error Reader and IR functions can only be accessed with the TRACE interface.

Partnumbers: TRACE Starter Kit (TRACE interface + software): 9-948-320-70
TRACE Software (for users of the I²C Link interface): 9-948-340-80
TRACE IR Add-on (IR interface + Remote Commander software): 9-948-320-80

PC requirements: IBM-compatible PC with operating system Windows95, Windows98, or WindowsNT*.

* WindowsNT only supported with TRACE interface

Sony Corporation
Sony UK
Service Promotions Dept.

9-974-994-01

English
00EP7174-1
Printed in U.K.
© 2000.5